

# Hydrogen Research in Flanders

Overview of Hydrogen related activities  
at Flemish knowledge institutes



Status January 2023



# Flanders wants to play a strong role in the European hydrogen story.



© Marco Merxens

**Minister Brouns**  
Flemish Minister of Economy,  
Science and Innovation

The transition to a sustainable and climate-proof society, one of the biggest challenges we face, will be a story of both green electrons and green molecules. In addition to electrification, hydrogen and its derivatives will also play an important complementary role in our energy transition. These green molecules will be essential for making our industry more sustainable.

The current geopolitical tensions have further reinforced the awareness that our economies need to become not only more sustainable but also much more resilient. Europe should advance more towards strategic autonomy and therefore it should be at the forefront of technological innovations in strategically important policy areas, such as energy and industry. Hydrogen is unequivocally a strategic technology.

The Flemish hydrogen vision of November 2020 aims to contribute to this. Flanders has the ambition to be a frontrunner in the European hydrogen story through sustainable innovation. We want to accelerate the energy transition while at the same time strengthen our economy by creating sustainable jobs in our region.

By fully investing in research and innovation, I want to further strengthen the Flemish industrial ecosystem, to give our Flemish companies and technology players every opportunity to grow in a globally promising market for hydrogen and hydrogen applications. In addition, I want to support the implementation of hydrogen and the many hydrogen applications in Flanders in order to support the sustainable transition in our industry.

An important strategic objective in this hydrogen vision is to strengthen research in the field of hydrogen at our Flemish knowledge institutions, as an important pillar in our knowledge economy. Research provides us with new insights and ideas for future innovations in our society, which are necessary to tackle the major societal challenges. It is important here that this new knowledge also finds its way into societal applications. Knowledge transfer and exchange between universities and research centers and companies is essential in this regard.

Last year the first edition of the 'inventory 'Hydrogen Research in Flanders' has been published, showing that we have a lot of academic expertise on hydrogen in our region. The aim of this inventory is to stimulate the research collaboration in the field of hydrogen between researchers and companies.

It can serve both as a basis for establishing good contacts with other research colleagues in the field to stimulate and strengthen collaborations as well as for companies to look for the right research expertise in various disciplines in the hydrogen field to build up a fruitful collaboration. The first edition of this inventory has already shown to be a useful first step to create new links between the activities of some Flemish companies and knowledge groups.

Let this second edition of the inventory 'Hydrogen Research in Flanders' be a source of inspiration for our common ambition to stimulate research and innovation collaboration in the field of hydrogen in Flanders.

# 1 Introduction

The role of hydrogen as one of the solutions in the energy transition is widely recognised. The topic is high on the EU agenda as one of the pillars to realise climate neutrality by 2050. Also in Flanders & Belgium, hydrogen is a hot topic, with the 'Hydrogen vision' of the Flemish government as starting point for further development and roll-out of hydrogen technology in our region. Flanders has a lot of expertise in the field of hydrogen, with a number of important technology players that are globally recognised for their products and expertise. However, if we want to maintain our leading position and continue to play a role in this rapidly evolving ecosystem, it is important to bring our research competences to the required level to feed and support our industry.

In our Flemish knowledge institutes several research groups are active in hydrogen related domains that are very relevant for the further development and scaling up of the hydrogen technology. Since the research on hydrogen related topics was rather fragmented and a clear overview of the different research activities was lacking, WaterstofNet has started to make an inventory of the different institutes and groups that have activities in this field.

The first catalogue 'Hydrogen Research in Flanders' was published in the beginning of 2022 . This catalogue provides an overview of most relevant research groups, categorized following their focus area in the hydrogen value chain (production & storage & transport & use of hydrogen; general hydrogen topics) and the type of research (material or process development, modelling).

This new document is an update of last year's catalogue, with the same structure and content, but with new data and topics added.

We hope this catalogue can be a practical guide for both research groups and industrial technology developers, to facilitate the search for certain skills and expertise in the field.

The ultimate aim of this overview is to stimulate collaboration among knowledge institutes and with industrial partners, it will enable identification of knowledge gaps and opportunities for new research topics and lead to definition of spearhead topics for our region.

The WaterstofNet team  
March 2023

---

<sup>1</sup> Mededeling aan de Vlaamse regering, Vlaamse Waterstofvisie "Europese koploper via duurzame innovatie"  
<https://www.vario.be/nl/nieuws/vlaamse-waterstofvisie-%E2%80%98europese-koploper-duurzame-innovatie%E2%80%99>

<sup>2</sup> [https://www.waterstofnet.eu/\\_asset/\\_public/WIC/WaterstofNet-Hydrogen-research-in-Flanders.pdf](https://www.waterstofnet.eu/_asset/_public/WIC/WaterstofNet-Hydrogen-research-in-Flanders.pdf)

## 2 Content and structure

The research activities in Flanders can be classified along the hydrogen value chain, from production of hydrogen from renewable energy, transport and storage of hydrogen and the use of hydrogen in industrial, mobility and power&heat applications. Some topics are applicable to the full value chain and are classified under “overarching topics”.

The conversion of renewable electricity and the integration of electrolyzers in the electricity grid is studied in a few research groups.

Several groups are active in material research related to electrochemical (electrolysis) or photo-electrochemical cells, for which new types of electrodes, membranes and catalysts are developed and tested. The ultimate goal is to obtain cheaper and more efficient electrolyzers that allow the scaling up of green hydrogen production that is expected to happen the coming years.

The further processing of the green hydrogen into more complex chemical building blocks (hydrocarbons) is also studied in several research groups. In (photo)-electro-chemical cells, CO<sub>2</sub> and water can be converted into different chemical components, via a co-electrolysis process. On the other hand, hydrogen and CO<sub>2</sub> can also react via a thermo-catalytic process (synthesis) into renewable fuels such as methanol or syngas. In both processes, catalysts play a very important role to increase the efficiency and define the process conditions.

The next step in the value chain is transport and storage of hydrogen. Liquid or solid hydrogen carriers are investigated to store the hydrogen at lower pressures and higher density. Clathrates to store hydrogen could be a possible breakthrough solution to facilitate hydrogen storage. Also storage and transport of hydrogen in liquid form is studied, with both simulation and testing of the dynamics of hydrogen flows.

Regarding the use of hydrogen for transport applications or to convert hydrogen into heat and power for other applications, several groups are active in development and testing of combustion engines operating on (liquid) hydrogen or derived fuels. Also fuel cells are tested. Hydrogen driven microbiological processes form a different use case for hydrogen, e.g. for the production of microbial proteins for future food supply.

Several over-arching subjects are studied at different institutes: interaction of hydrogen with steel and other materials, techno-economic analysis and life cycle assessment of the different production and valorisation paths of hydrogen, safety aspects and even geo-political aspects of the future large scale hydrogen economy.

An overview of the hydrogen value chain and the different topics that are studied at the different Flemish institutes are visualized in the figure on the next page.

# Academic H<sub>2</sub>-related research Flanders

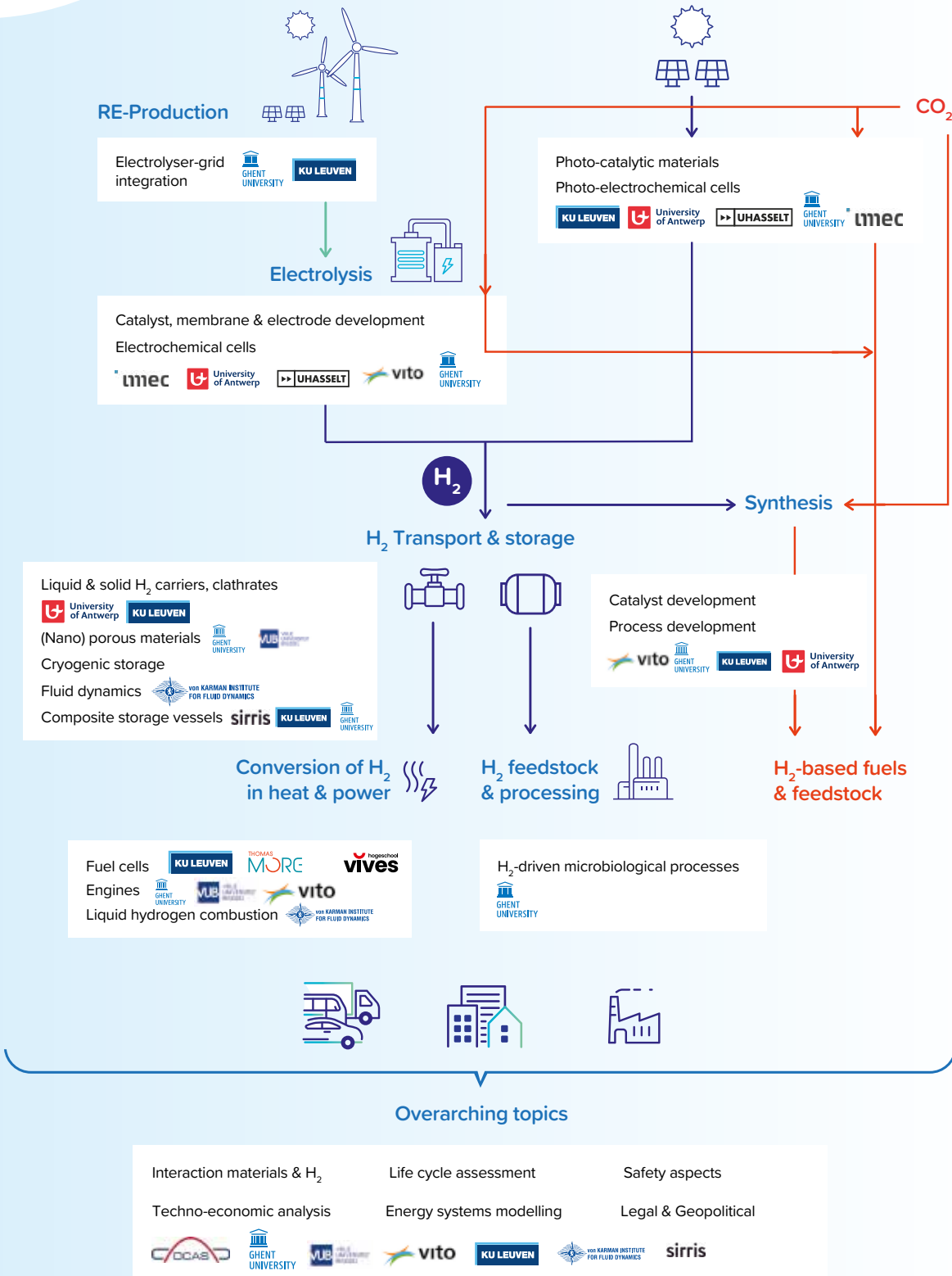

## Content

1	Introduction	2
2	Content and structure	3
3	Production, storage and transport of hydrogen	7
	UAntwerpen: Applied Electrochemistry and Catalysis (ELCAT)	8
	UAntwerpen: Department of Bioscience Engineering/ Sustainable Energy, Air and Water Technology Group (DuEL)	11
	UAntwerpen: Department of Chemistry/ LADCA	13
	UAntwerpen: Plasma Lab for Applications in Sustainability and Medicine – Antwerp (PLASMANT)	15
	KU Leuven: COK-KAT	17
	U Hasselt: Institute for Materials Research (IMO-IMOMECE) / Chalcogenides for Energy Applications	19
	UHasselt: Institute for Materials Research (IMO-IMOMECE) / Design and synthesis of inorganic nanomaterials (DESINE)	22
	UHasselt: Institute for Materials Research (IMO-IMOMECE) / Group of Electrochemical Engineering	25
	UHasselt: Institute for Materials Research (IMO-IMOMECE) / Hybrid Halide Perovskites for Energy Applications (HyMaD)	27
	UHasselt: Institute for Materials Research (IMO-IMOMECE) / Organic Opto-Electronics Research (OOE)	30
	UGent: Dept. Solid State Sciences - Research group COCOON	32
	UGent: Laboratory for Chemical Technology	35
	UGent: Particle and Interfacial Technology Group (PaInT)	37
	UGent: Center for Ordered Materials, Organometallics & Catalysis	39
	VITO: Sustainable chemistry	41
	Imec: Energy Department	44
	UGent: Center for Molecular Modeling	46
	UGent: Industrial Catalysis and Adsorption Technology (INCAT)	48
	UGent: Pore-scale Processes in Geo-materials (PProGress)	50
	UGent: Mechanics of Materials and Structures (MMS)	53
	KULeuven: Mecha(tro)nic System Dynamics (LMSD) and Composite Materials Group	55
	KULeuven: Computational Materials Science	59
	VUB: Department of Chemical Engineering	61
	Sirris: Precision Manufacturing	63
	Sirris: Product Development Hub	65
	Sirris: Additive Manufacturing	67
	VKI: Research Expertise Group on Liquid & Solid Propulsion	69

KU Leuven; Department of Electrical Engineering/ Electrical Energy Applications Ghent	71
UGent: Dept. Electromechanical, Systems and Metal Engineering – EELAB & Lemck	72
<b>4 Use of hydrogen</b>	<b>74</b>
VUB: FLOW: Thermo and Fluid Dynamics	75
VKI: Research Expertise Group on Liquid & Solid Propulsion	76
VKI: Research Expertise Group on High Speed Propulsion & Combustion	80
UGent: Transport Technology	83
THomas More: De Nayer/ Automotive	85
VIVES :Centre of expertise smart technologies – research group hydrogen	87
KU Leuven: Mechanical Engineering Department/ Applied Mechanics and Energy Conversion (TME) Division	90
UGent: Applied thermodynamics & heat transfer	94
<b>5 Hydrogen general topics</b>	<b>96</b>
VUB: Department of Materials and Chemistry MACH/ Research Group Electrochemical and Surface Engineering SURF	97
UGent: Mechanical Construction - Soete Laboratory	99
UGent: Sustainable Materials Science	101
OCAS: Metallurgy department	104
OCAS: Department applications and solutions	107
OCAS: Department surface engineering	109
KULeuven: Dept. Materials Engineering/Surface and Interface Engineered Materials (New Materials/iR)	111
Sirris: Harsh environment	113
KU Leuven: Department of Mechanical Engineering/ Energy Systems Integration and Modeling (ESIM) Research Group	115
VITO: Techno-economic assessments and LCA analysis	117
UGent: Sustainable Systems Engineering (STEN)	120
VKI: Research Expertise Group on Environmental Flows & Safety; Research Expertise Group on Industrial Flows	122
UGent: Center for Microbial Ecology and Technology	124
UGent: Ghent Institute for International Studies/ Centre for Sustainable Development	126
UGent: Centre of environmental & energy law	128



### 3 Production, storage and transport of hydrogen

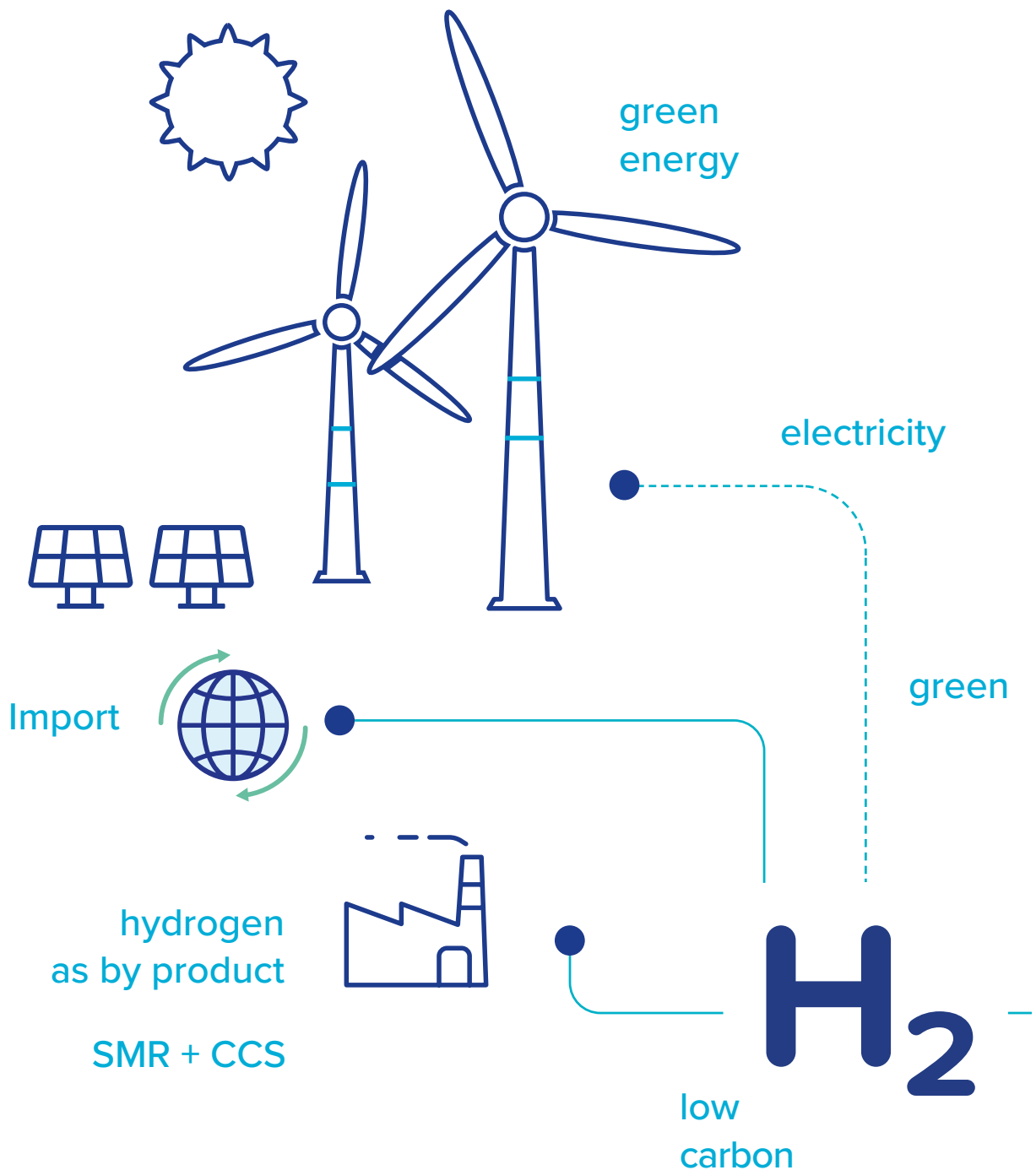

## UAntwerpen: Applied Electrochemistry and Catalysis (ELCAT)

### UAntwerpen, Applied Engineering

#### General expertise of the research group

The core research activities within ELCAT are related to the development of state-of-the-art electrochemical reactors and catalysts, with a view towards large-scale industrial development in the field of industrial electrification, in a green and sustainable way to ultimately replace the traditional chemical processes. The scope there is to improve controllability, flexibility and energy efficiency of the reactions through electrocatalyst and reactor design. This research can thus be subdivided in three main topics, which are interrelated: (i) electrocatalysis, (ii) electrosynthesis and (iii) electrochemical reactor engineering. From those research topics, two major aspects of the identity as a group clearly come to the surface: (1) industrial application and (2) green chemistry.

#### Specific hydrogen-related expertise & research topics

- Photo-)electrochemical production of hydrogen with a focus on component and reactor development, in-house developed flow-electrolyzers (alkaline and proton-exchange)
- Hydrogen evolution going from catalyst development through GDE preparation and reactor development, with a focus on novel 3D electrodes to improve reactor hydrodynamics (e.g. bubble release, mass transfer, etc.)
- Electrochemical production of formic acid and other CO<sub>2</sub>-derived chemicals as potential hydrogen carriers, utilizing renewable energy

#### Available equipment/tools:

- A wide range of electrosynthesis set-ups going from batch cells to flow-cells in combination with advanced potentiostats, including boosters required for achieving higher currents.
- Electrocatalyst synthesis equipment for wet chemical and electrodeposited catalyst manufacturing: atmosphere controlled oven, elevated temperature and cryogenic synthesis cells, spray coating, rotavap, hydrostatic pressure vessels, TGA, etc.
- All analytical equipment, including (in-line) GC, HPLC, ICP-MS, DEMS, UV-VIS, etc. to determine the reaction performance and product outcome.
- Necessary pumps and sensors (e.g. pressure, flow, pH) to monitor all operating conditions.
- Explosion-safe oven to allow operation at elevated temperatures.
- Additionally, ELCAT possesses the required equipment to develop optimized electrolyzers at different scales (from 1 cm<sup>2</sup> to 200 cm<sup>2</sup>). It can count on its own MP 45, ISEL milling machine, high-end 3D metal and polymer printers, an accurate 3D laser micromachining setup, a sputter coater and in the future also an automated spray coater.

### International collaborations:

ELCAT is part of the Center of Excellence on Catalysis at UAntwerp. Additionally, T. Breugelmans is part of the group of experts determining the course of the Capture pipeline with respect to CO<sub>2</sub> conversion.

On an international level, ELCAT has close collaborations with ElectroCat in Slovenia, ICMM-CSIC in Spain, Forschungszentrum Jülich in Germany, TU Delft in the Netherlands, Fritz Haber Institute in Germany, National Laboratories, etc.

### Participating in FL/B/EU funded projects with H<sub>2</sub> related research:

- E2C – Electrons to Chemicals
  - Topic: this cross-border project focuses on the conversion of CO<sub>2</sub> into chemicals and fuels, using renewable electricity
  - Funding source: INTERREG 2Seas
  - Main partners: VITO, TNO, TU Delft, University of Lille
- Threading-CO<sub>2</sub>
  - Topic: Develop CO<sub>2</sub> to CO electrolyzers at pilot and demonstration scale.
  - Funding source: Horizon Europe
  - Main partners: Fairbrics, Deutsche institute fur textil- und faserforschung denkendorf, etc.
- SYN-CAT
  - Develop electrocatalysts and photo-electrocatalytic reactor for the conversion of CO<sub>2</sub> to methanol.
  - Funding: VLAIO-MOT
  - Main partners: UHasselt, Imec, UGent, VUB
- CLUE
  - Topic: Develop electrocatalytic reactor for the conversion of CO<sub>2</sub> into ethylene at larger scale and directly from flue gases.
  - Funding source VLAIO-MOT
  - Main partners: KU Leuven, VITO
- FWO-WOG (CAPTURE):
  - Topic: scientific research committee on CO<sub>2</sub> conversion
  - Funding sources: WOG
- FWO-WEAVE proposal
  - Topic: Understanding the role of dopants as a key step towards efficient oxygen evolution catalysts
  - Funding source: FWO-WEAVE
  - Main partners: National Institute of Chemistry, Slovenia

### Patented zero-gap reactor



2A/cm<sup>2</sup> current density  
T range: 25 – 100°C  
P range: up to 2 bar  
Targeted voltage: < 2.5 V

## Main relevant publications

- Geboes B., Mintsouli I., Wouters B., Georgieva J., Kakaroglou A., Sotiropoulos S., Valova E., Armyanov S., Hubin A., Breugelmans T., Applied Catalysis B: Environmental, 2014, 150-151, 249.
- Sanchez Gutierrez O., Birdja Y., Bulut M., Vaes J., Breugelmans T., Pant D., Current Opinion in Green and Sustainable Chemistry, 2019, 16, 47-56.
- Daems N., Choukroun D., Merino P., Rettenmaier C., Pacquets L., Bergmann A., Santoro G., Vazquez L., Martinez L. Roldan Cuenya B., Martin Gago J.A., Breugelmans T., ACS Applied Materials & Interfaces, 2022, 14, 2691.
- D. Choukroun, N. Daems, T. Kenis, T. Van Everbroeck, J. Hereijgers, T. Altantzis, S. Bals, P. Cool, T. Breugelmans, The Journal of Physical Chemistry C, 2020, 124, 1369.
- De Mot B., Hereijgers J., Duarte M., Breugelmans T., Chemical Engineering Journal, 2020, 378, 122224-122232.
- De Mot B., Ramdin M., Hereijgers J., Vlugt T., Breugelmans T., ChemElectroChem, 2020, 7, 3839.
- Duarte M., De Mot B., Hereijgers J., Breugelmans T., ChemElectroChem, 2019, 6, 5596.
- Van Daele K., De Mot B., Pupo M., Daems N., Deepak P., Kortlever R., Breugelmans T., ACS Energy Letters, 2021, 6, 4317

## Contact persons:

Tom Breugelmans, spokesperson ([tom.breugelmans@uantwerpen.be](mailto:tom.breugelmans@uantwerpen.be))

Jonas Hereijgers, professor researcher ([jonas.hereijgers@uantwerpen.be](mailto:jonas.hereijgers@uantwerpen.be))

Nick Daems, post-doctoral researcher ([nick.daems@uantwerpen.be](mailto:nick.daems@uantwerpen.be))



## UAntwerpen: Department of Bioscience Engineering/ Sustainable Energy, Air and Water Technology Group (DuEL)

### University of Antwerp & Faculty of Science

#### General expertise of the research group

*The Sustainable Energy, Air and Water Technology Group (DuEL) focuses on research areas: (1) purification technologies for various side and waste streams, (2) solar energy utilisation, (3) microbial cleantech and (4) hydrogen technology. Concerning the latter DuEL focusses on the use of H<sub>2</sub> as a fuel via i) techno-economical and feasibility analysis for mobile applications, ii) characterisation of H<sub>2</sub> carriers (thermal and chemical stability, kinetics, catalyst design), iii) design of chemical reactors for the storage and release of H<sub>2</sub> to and from liquid and solid carriers, following process intensification, and (iv) the production of H<sub>2</sub> from abundant sources (e.g. seawater) or waste streams.*

#### Specific hydrogen- related expertise & research topics

- Characterization of H<sub>2</sub> carriers (thermal and chemical stability, kinetics, catalyst design). Liquid and solid H<sub>2</sub> carriers.
- Gas phase analysis of H<sub>2</sub> release reactions.
- Techno-economical and feasibility analysis for mobile applications
- Evaluation of innovative H<sub>2</sub> production pathways (e.g. seawater splitting, H<sub>2</sub> recovery from aqueous and gaseous waste streams). Direct photoelectrochemical production.
- Design of multiphase chemical reactors for H<sub>2</sub> storage and release, following the principles of process intensification
- Process simulations and CFD-assisted reactor design and optimization simulations

#### Participating in FL/B/EU funded projects with H<sub>2</sub> related research:

- “Electrified chemical reactor for fast release of hydrogen (H<sub>2</sub>) from liquid organic hydrogen carriers (LOHCs) for generator set (genset). H<sub>2</sub> genset testing on a ship (Port of Future)”. University of Antwerp (IOF SBO).
- “CFD-Assisted Design of an Innovative Multiphase Chemical Reactor for Hydrogen Release”. University of Antwerp (BOF DOCPRO).
- “Photoelectrochemical abatement of methane waste with simultaneous energy recovery” (FWO aspirant fundamental)
- “Solar hydrogen production from seawater using stabilized plasmonic photocatalysts”. (FWO aspirant fundamental)
- “In-line quantization of the hydrogen gas yield from photoelectrochemical treatment of volatile organic compounds” (FWO research grant)
- ARCLATH (FL – Moonshot sprint cSBO): hydrogen storage in artificial clathrates

### International collaborations:

Peter Wasserscheid, Hydrogenious

### Main relevant publications

- Van Hoecke L., Laffineur L. , Campe R. , Perreault P. , Verbruggen S. W., Lenaerts S.\* (2021). "Challenges in the use of hydrogen as a maritime fuel." *Energy & Environmental Science*. (IF = 30.289)
- Kummamuru N.B., Perreault P.\* , Lenaerts S. A New Generalized Empirical Correlation for Predicting Methane Hydrate Equilibrium Conditions in Pure Water. (2021) *Industrial & Engineering Chemistry Research*. (IF= 3.573)
- Verbruggen S.W.\*, Van Hal M., Bosserez T., Rongé J., Hauchecorne B., Martens J.A., Lenaerts S. (2017) Harvesting Hydrogen Gas from Air Pollutants with an Unbiased Gas Phase Photoelectrochemical cell. *ChemSusChem* 10, 1413-1418. (IF= 7.804)
- Dingenen F., Verbruggen S.W.\* (2021) Tapping Hydrogen Fuel from the Ocean: a Review on Photocatalytic, Photoelectrochemical and Electrolytic Splitting of Seawater. *Renewable and Sustainable Energy Reviews* 142, 110866. (IF = 12.110)
- Rongé J., Deng S., Pulinthanathu S., Bosserez T., Verbruggen S.W., Kumar Singh N., Dendooven J. Roeffaers M.B.J., Taulelle F., De Volder M., Detavernier C., Martens J.A. (2014) Air-based photoelectrochemical cell capturing water molecules from ambient air for hydrogen production. *RSC Advances* 4, 29286-29290. (IF = 3.119)

### Contact persons:

Prof. Dr. Silvia Lenaerts, Prof. Dr. S.W. Verbruggen, Prof. Dr. P. Perreault  
[silvia.lenaerts@uantwerpen.be](mailto:silvia.lenaerts@uantwerpen.be) [sammy.verbruggen@uantwerpen.be](mailto:sammy.verbruggen@uantwerpen.be) [patrice.perreault@uantwerpen.be](mailto:patrice.perreault@uantwerpen.be)  
Tel. 032653693  
Groenenborgerlaan 171  
2020 Antwerpen, Belgium

## UAntwerpen: Department of Chemistry/ LADCA

### University of Antwerp, Faculty of Science

#### General expertise of the research group

The Laboratory of Adsorption and Catalysis (LADCA) is a pioneer in the synthesis and applications of porous materials and metal-oxides in the field of adsorption and catalysis. The research activities in the laboratory of Adsorption and Catalysis are focussed on: - The development of new micro- and mesoporous inorganic materials; - Optimization of synthesis pathways for inorganic materials with a controlled porosity and surface properties; - Catalytic activation of porous materials; - Optimization of porous materials for efficient gas- and liquid separations; - Characterization of porous materials; -Catalytic applications (redox – and photocatalysis)

#### Specific hydrogen- related expertise & research topics

- Design of heterogeneous catalysts for in-situ hydrogen production for sustainable reduction reactions in water (BOF-GOA project in collaboration with the Organic Chemistry group (prof. B. Maes).
- Development of porous materials with tuned properties as matrix for hydrogen clathrate formation (Vlaio Moonshot project on Artificial clathrates for safe storage, transport and delivery of hydrogen (ARCLATH))
- Photocatalytic and photo-electrocatalytic reduction of CO<sub>2</sub> with hydrogen into added value chemicals (Vlaio Moonshot D2M and Vlaio Moonshot SYN-CAT projects)

#### Available equipment/tools:

- Micro-Raman, in-situ Raman
- FT-IR, in-situ FT-IR
- UV-VIS
- TGA/DTG, TGA-MS
- N<sub>2</sub>-sorption, chemisorption
- TOC
- TPR, TPO
- Photocatalytic set-ups and lamps
- Reactors (photocatalytic, plasma and automotive)
- GC detection

#### International collaborations:

- UNIPD, Padova, Italy
- NCSR Athens, Greece
- National Institute of Chemistry, Ljubljana, Slovenia
- University of Alicante, Alicante, Spain
- Technical University Gheorghe Asachi, Iasi, Romania
- ENMIX (European Nanoporous Materials Institute of Excellence aisbl)
- DZA (Dutch zeolite association)

## Main relevant publications

- Meynen V., Cool P., Vansant E.F. - Verified syntheses of mesoporous materials – Microporous and Mesoporous Materials (special issue), 125/3, 169-224, 2009 (# citations: 468; highly cited paper)
- Suligoj A., Arcon I., Mazaj M., Drazic G., Arcon D., Cool P., Stangar U.L., Tusar N.N., Surface modified titanium dioxide using transition metals: nickels as winning transition metal for solar light photocatalysis, *J. Mat. Chem. A*, 6 (21), 9882-9892, 2018
- Xin Q., Papavasiliou A., Boukos N., Glisenti A., Li JPH, Yang Y., Philippopoulos C.J., Poulakis E., Katsaros F.K., Meynen V., Cool P., Preparation of CuO/SBA-15 catalyst by the modified ammonia driven deposition precipitation method with a high thermal stability and an efficient automotive CO and hydrocarbons conversion, *Applied Catalysis B- Environmental*, 223, 103-115, 2018
- R. Janus, M. Wadzyk, P. Natkanski, P. Cool, P. Kustrowski, Dynamic adsorption-desorption of methyl ethyl ketone on MCM-41 and SBA-15 decorated with thermally activated polymers, *Journal of Industrial and Engineering Chemistry*, 71, 465-480, 2019
- N. Blommaerts, N. Hoeven, D. Arenas Esteban, R. Campos, M. Mertens, R. Borah, A. Glisenti, K. De Wael, S. Bals, S. Lenaerts, S.W. Verbruggen, P. Cool, Tuning the turnover frequency and selectivity of photocatalytic CO<sub>2</sub> reduction to CO and methane using platinum and palladium nanoparticles on Ti-Beta zeolites, *Chemical Engineering Journal* 410, 128234, 2021
- R.-G Ciocarlan, N. Hoeven, E. Irtem, V. Van Acker, M. Mertens, E.M. Seftel, T. Breugelmans, P. Cool, Ferrite@TiO<sub>2</sub>-nanocomposites as Z-scheme photocatalysts for CO<sub>2</sub> conversion: Insight into the correlation of the Co-Zn metal composition and the catalytic activity, *Journal of CO<sub>2</sub> Utilization*, 36, 177-186, 2020
- Y. Uytendhouwen, V. Meynen, P. Cool, A. Bogaerts, The potential use of core-shell structured spheres in a packed-bed DBD plasma reactor for CO<sub>2</sub> conversion, *Catalysts*, 10, 5, 2020, DOI: 10.3390/catal10050530

## Contact persons:

Prof. Pegie Cool  
Laboratory of Adsorption and Catalysis (LADCA)  
Department of Chemistry, University of Antwerp  
Universiteitsplein 1  
B-2610 Wilrijk  
[pegie.cool@uantwerpen.be](mailto:pegie.cool@uantwerpen.be)





## UAntwerpen: Plasma Lab for Applications in Sustainability and Medicine – Antwerp (PLASMANT)

### UAntwerpen, Faculty of Science

#### General expertise of the research group

In the research group PLASMANT we are studying plasma and plasma-surface interactions by means of computer modelling and experiments, for two main applications, i.e.:

- Green chemistry, including CO<sub>2</sub>, CH<sub>4</sub> and N<sub>2</sub> conversion into value-added chemicals and fuels, or into fertilizers, but also NH<sub>3</sub> cracking for green H<sub>2</sub> production
- Plasma medicine, focusing mainly on cancer treatment, but also virus inactivation

The aim is to obtain better insights in the underlying mechanisms, in order to improve the applications. Indeed, plasma technology is very promising for green chemistry, as energy-efficient alternative to the existing classical conversion methods, because the splitting of inert molecules (such as CO<sub>2</sub>, CH<sub>4</sub> and N<sub>2</sub>) is initiated by energetic electrons present in the plasma

We have several types of plasma reactors for green chemistry, and several plasma sources for cancer treatment.

#### Specific hydrogen- related expertise & research topics

- Plasma-based CH<sub>4</sub> conversion into H<sub>2</sub> (and value-added carbon) and into higher hydrocarbons (e.g., ethylene, acetylene) and oxygenates
- Plasma-based dry reforming of methane, including plasma catalysis, for the production of syngas and other value-added chemicals and fuels
- Plasma-based H<sub>2</sub> synthesis from other hydrocarbons (e.g., methanol, ethanol, and even plastic waste pyrolysis products), as well as from NH<sub>3</sub>.
- We perform research for all these applications, by a combination of plasma chemistry and plasma reactor modeling, and experiments.

#### Available equipment/tools:

- Various gliding arc plasma reactors, atmospheric pressure glow discharges, microwave plasmas and dielectric barrier discharge plasmas,
- Analysis equipment (GC, MS, non-dispersive IR/UR, optical sensors) for gas conversion.
- Various types of models: quasi-1D chemical reaction kinetics models, 2D/3D fluid dynamics simulations, Monte Carlo, particle-in-cell Monte Carlo, hybrid models, molecular dynamics, density functional theory simulations.

#### International collaborations:

- DIFFER (Dutch Institute for Fundamental Energy Research); Eindhoven University of Technology; Maastricht University; University of Liverpool; University of Messina; University of Warwick; University of Adelaide; University of Manchester; University of Notre Dame; Dalian University of Technology; CSIRO-Australia;...
- Annemie Bogaerts has an ERC Synergy Grant “SCOPE”, together with G. Centi, V. Hessel and E. Rebrov: See website: <http://ww2new.unime.it/scope/>

### Participating in FL/B/EU funded projects with H<sub>2</sub> related research:

- Cracking of green ammonia to hydrogen using innovative catalyst and adsorbent assisted plasma technology (ETF project “HYPACT”).
- Energy-efficient plasma conversion of greenhouse gases to methanol, the fuel of the future (BlueApp POC project “OPTANIC”).
- Plasma-based green hydrogen synthesis from hydrocarbons (FWO-FNRS EOS project “PLASynthH2”).
- Power to olefins: Electrified steam cracking and plasma booster (Moonshot SBO project “P2O”).
- Surface-CONfined fast-modulated Plasma for process and Energy intensification in small molecules conversion (ERC Synergy Grant “SCOPE”).

### Main relevant publications

- Sustainability analysis of methane-to-hydrogen-to-ammonia conversion by integration of high-temperature plasma and non-thermal plasma processes; Energy conversion and management - ISSN 0196-8904-269 (2022) p. 1-15; Jose Osorio-Tejada, Kevin van 't Veer, Nguyen Van Duc Long, Nam N. Tran, Laurent Fulcheri, Bhaskar S. Patil, Annemie Bogaerts, Volker Hessel
- Plasma-catalytic ammonia decomposition using a packed-bed dielectric barrier discharge reactor; International journal of hydrogen energy - ISSN 0360-3199-47:75 (2022) p. 32081-32091; J.A. Andersen, J.M. Christensen, M. Østberg, Annemie Bogaerts, A.D. Jensen
- Dry reforming of methane in an atmospheric pressure glow discharge : confining the plasma to expand the performance; Journal of CO<sub>2</sub> utilization - ISSN 2212-9839 - 56(2022), 101869; Wanten Bart, Maerivoet Stein, Vantomme Christine, Slaets Joachim, Trenchev Georgi, Bogaerts Annemie
- Plasma-enabled catalyst-free conversion of ethanol to hydrogen gas and carbon dots near room temperature; Chemical engineering journal - ISSN 1385-8947 - 382(2020), 122745; Zhou Rusen, Zhou Renwu, Xian Yubin, Fang Zhi, Lu Xinpei, Bazaka Kateryna, Bogaerts Annemie, Ostrikov Kostya (Ken)

### Contact persons:

Annemie Bogaerts, spokesperson ([annemie.bogaerts@uantwerpen.be](mailto:annemie.bogaerts@uantwerpen.be))

## KU Leuven: COK-KAT

### KU Leuven, Bioscience engineering (COK-KAT)

The research team has a strong focus on porous materials, catalysis and adsorption. The emphasis is on three major themes related to grand societal challenges: water, energy and human health. Energy research is concentrated on solar fuels (hydrogen, formic acid, ammonia), and hydrogen storage. Molecular aspects of water upon confinement in nanopores relevant to electrolytic processes producing hydrogen are investigated.

#### Specific hydrogen- related expertise & research topics:

- Solar hydrogen production via advanced photoelectrochemical (PEC) cells
- Storage of hydrogen in clathrate hydrates
- Electrocatalysis for CCU and ammonia production

#### Available equipment/tools:

- Workstation for advanced testing of photoelectrochemical cells & components, electrochemical reactors
- Outdoor pilot setups for testing hydrogen panels
- Analytical equipment including ion chromatography, mass spectrometry
- Solid state NMR spectroscopy for characterizing hydrogen storage materials

#### Participating in FL/B/EU funded projects with H<sub>2</sub> related research:

(See <https://solhyd.org/en/projects-overview/> )

- HYPFR (FL – Moonshot LSI): production and demonstration of hydrogen panels
- CATCO<sub>2</sub>RE (FL – SBO)(KUL, UGent, VITO, VUB): Catalytic CO<sub>2</sub> Reduction to Solar Fuels and Chemicals
- CO<sub>2</sub>PERATE (FL – cSBO)(KUL, UGent, UA, VITO, BBEU): All renewable CCU based on formic acid integrated in an industrial microgrid
- PROCURA (BE – ETF)(KUL/Energyville, Waterstofnet, VUB, ULiège): Power-to-X and carbon capture & utilization roadmap for Belgium
- HyPERfarm (EU – H2020)(KUL, Aarhus, Fraunhofer): Hydrogen and photovoltaic electrification on farm
- P2C (FL – Moonshot sprint cSBO) : synthesis of green ammonia using electrolysis and plasma technology
- ARCLATH (FL – Moonshot sprint cSBO): hydrogen storage in artificial clathrates
- WATUSO (EU – ERC AdG): nanoconfined water: a tunable solvent system



### Main relevant publications

- Thijs et al. (2021). Selective electrochemical reduction of CO<sub>2</sub> to formic acid in a gas phase reactor with by-product recirculation. *Sustainable Energy Fuels*, doi: 10.1039/d1se00218j
- Hollevoet et al. (2020). Energy-Efficient Ammonia Production from Air and Water Using Electrocatalysts with Limited Faradaic Efficiency. *ACS Energy Letters*, 5(4), 1124–1127.
- Rongé et al. (2019). Bifunctional earth-abundant phosphate/phosphide catalysts prepared via atomic layer deposition for electrocatalytic water splitting. *Nanoscale Advances*, 1(10), 4166–4172.
- Ahmad et al. (2019). Triple-Cation-Based Perovskite Photocathodes with AZO Protective Layer for Hydrogen Production Applications. *ACS Applied Materials and Interfaces*, 11, 23198–23206.
- Trompoukis et al. (2018). Porous multi-junction thin-film silicon solar cells for scalable solar water splitting. *Solar Energy Materials and Solar Cells*, 182, 196–203.
- Heremans et al. (2017). Vapor-fed solar hydrogen production exceeding 15% efficiency using earth abundant catalysts and anion exchange membrane. *Sustainable Energy Fuels*, 1, 2061–2065.
- Rongé et al. (2014). Air-Based Photoelectrochemical Cell Capturing Water Molecules from Ambient Air for Hydrogen Production. *RSC Advances*, 4(55), 29286–29290.
- Rongé et al. (2014). Monolithic cells for solar fuels. *Chemical Society Reviews*, 43, 7963–7981.

### Contact persons:

- Johan Martens (johan.martens@kuleuven.be)
- Jan Rongé (jan.ronge@kuleuven.be)  
[www.solhyd.org](http://www.solhyd.org)

## *U Hasselt: Institute for Materials Research (IMO-IMOMECC) / Chalcogenides for Energy Applications*

Hasselt University, Engineering Technology  
Imec Associated Laboratory

Our team consists of around 16 members including 5 senior researchers, 7 PhD students and various thesis/internship students with strong expertise in the development of chalcogenide materials, and advanced opto-electrical characterization. This team also focuses on engineering photovoltaic (PV) devices and developing solar fuel (photo-electrochemical approach) pathways.

### Specific hydrogen- related expertise & research topics

- Development of high-efficiency PV tandem devices which can be integrated to water electrolytic cells for PV-EC applications.
- Engineering various chalcogenide materials as photoabsorbers and cocatalysts for photoelectrochemical water splitting.
- Designing flowcells and electrode materials for efficient and low-overpotential electrocatalytic hydrogen generation systems.
- Advanced opto-electrical, structural, and configuration characterization of potential materials and devices applicable to PV and photo-electrochemical studies.

### Available equipment/tools:

- Tabletop Tescan SEM
- Hall Setup
- Steady state and transient Photoluminescence spectrometer
- X-ray diffractometer
- Secondary Ion Mass Spectrometer
- Photoelectron Spectrometer
- Photocurrent spectrometer
- Solar simulators
- Electrochemical potentiostat and electrodes

## Participating in FL/B/EU funded projects with H<sub>2</sub> related research

- Development of high-efficiency tandem PV, e.g. for PV-EC
  - PERCISTAND (<https://cordis.europa.eu/project/id/850937>)  
Development of all thin-film perovskite on cis tandem photovoltaics
  - LASERGRAPH (<https://www.era-learn.eu/network-information/networks/fetflag-02-2018/flag-era-joint-transnational-call-jtc-2019/in-situ-laser-fabrication-of-graphene-electrodes-and-interlayers-for-next-generation-cigs-perovskite-solar-cells>)  
In-situ laser fabrication of graphene electrodes and interlayers for next generation CIGS/ Perovskite solar cells
  - LAFLEX2T (<https://projecten.topsectorenergie.nl/projecten/flexible-large-area-2t-monolithic-tandem-psc-cigs-33526>)  
Flexible Large area 2T monolithic Tandem PSC-CIGS
  - ARLEA (<https://www.uhasselt.be/nl/projecten/detail/23616-project-r-13035>)  
Advanced Recombination Junction Layer Engineering and Application for Scalable and Stable Monolithic Perovskite Tandem Solar Cells with Two Different Bottom Cells. (Si-CIGS)
- Development of chalcopyrite materials for photo-electrochemical applications
  - SYNCAT ( <https://moonshotflanders.be/mot3-syn-cat/>)  
Synergetic design of catalytic materials for integrated photo-and electrochemical CO<sub>2</sub> conversion
  - NanoCCU (<https://moonshotflanders.be/mot3-nano-ccu/>)  
Convert CO<sub>2</sub> from flue gasses into a valuable platform molecule for the chemical industry.
  - T-REX (<https://www.uhasselt.be/en/projects/detail/21780-project-r-12321>)  
Conversion of CO<sub>2</sub> into renewable materials via electrified routes
  - Procura Belgium (<https://procurabelgium.be/en>)  
Power to X, carbon capture & utilization roadmap for Belgium
- Development of kesterite materials for photo-electrochemical applications
  - KESPER (<https://www.uhasselt.be/en/projects/detail/24269-project-r-13406>)  
Kesterite-based Photoelectrodes for Water and Nitrogen Reduction

Hydrogen Booster, EMR Interreg project (<https://www.emrh2booster.eu/>)

Energy transition towards the development of carbon-free energy solutions by SMEs.



### International collaborations:

International Iberian Nanotechnology Laboratory, Portugal

Technical University of Denmark

Foundation for Research and Technology Hellas, Greece

Univerza v Ljubljani, Slovenia

Karlstad University, Sweden

### Main relevant publications

- de Wild, J., Scaffidi, R., Brammertz, G., Birant, G. and Vermang, B. (2023), Dielectric Front Passivation for Cu(In,Ga)Se<sub>2</sub> Solar Cells: Status and Prospect. *Adv. Energy Sustainability Res.* 2200132. <https://doi.org/10.1002/aesr.202200132>
- Ramesh, S., Tuomiranta, A., Hajjiah, A., M. Meuris, B. Vermang, J. Poortmans. Physics-based electrical modelling of CIGS thin-film photovoltaic modules for system-level energy yield simulations. *npj Flex Electron* 6, 87 (2022). <https://doi.org/10.1038/s41528-022-00220-5>
- Birant, G., de Wild, J., Meuris, M., Poortmans, J. and Vermang, B. (2022), "To Spin or Not to Spin?"— Is Spin-Coating the Ideal Technique for Pre-Deposition of Sodium Fluoride for CIGS Rear Surface Passivated Ultrathin Solar Cells?. *Phys. Status Solidi A*, 219: 2100830. <https://doi.org/10.1002/pssa.202100830>
- Joao Silvano, Jacopo Sala, Tamara Merckx, Yinghuan Kuang, Pieter Verding, Jan D'Haen, Tom Aernouts, Bart Vermang and Wim Deferme, *EPJ Photovolt.*, 13 (2022) 12 <https://doi.org/10.1051/epjpv/2022008>
- D. G. Buldu, de Wild, J., Kohl, T., Birant, G., Brammertz, G., Meuris, M., Poortmans, J., Vermang, B., "A Novel Strategy for the Application of an Oxide Layer to the Front Interface of Cu(In,Ga) Se<sub>2</sub> Thin Film Solar Cells: Al<sub>2</sub>O<sub>3</sub>/HfO<sub>2</sub> Multi-Stack Design With Contact Openings," in *IEEE Journal of Photovoltaics*, vol. 12, no. 1, pp. 301-308, Jan. 2022, <https://doi.org/10.1109/JPHOTOV.2021.3120515>.
- Ratz, T., Nguyen, N. D., Brammertz, G., Vermang, B., Jean-Yves Raty, J.-Y., Relevance of Ge incorporation to control the physical behaviour of point defects in kesterite, *J. Mater. Chem. A*, 2022,10, 4355-4365, <https://doi.org/10.1039/d1ta09620f>
- Martulli, A, Rajagopalan, N, Gota, F, Meyer, T, Paetzold, U.W., Claes, S, Salone, A, Verboven, J, Malina, R, Vermang, B, Lizin, S, Towards market commercialization: Lifecycle economic and environmental evaluation of scalable perovskite solar cells. *Prog Photovolt Res Appl.* 2022; 1- 15. <https://doi.org/10.1002/pip.3623>
- D. G. Buldu, J. de Wild, T. Kohl, G. Birant, G. Brammertz, M. Meuris, J. Poortmans, B. Vermang, *Sol. Energy* 2022, 237, 161. <https://doi.org/10.1016/j.solener.2022.04.003>

### Contact person

Prof. Bart Vermang,

<https://www.uhasselt.be/fiche?email=bart.vermang>

Email: [bart.vermang@uhasselt.be](mailto:bart.vermang@uhasselt.be)

## UHasselt: Institute for Materials Research (IMO-IMOMEC)/ Design and synthesis of inorganic nanomaterials (DESINe)

Hasselt University, Science faculty, Chemistry

### General expertise of the research group

The DESINe group is led jointly by Marlies Van Bael (gewoon hoogleraar, full professor) and An Hardy (hoogleraar, professor) at the Institute of Materials Research of UHasselt, which is also an affiliated lab of imec (division imomec) and partner in Energyville. The core expertise is chemical solution-based synthesis of inorganic nanomaterials, mainly oxides, metals, phosphates, sulphides and thiophosphates, with a main interest in the understanding of relations between synthesis, material properties and functional properties. The investigated synthesis routes include aqueous and non-aqueous sol-gel, solution-gel, hydro/solvothermal synthesis, thermal decomposition, combustion and (co)precipitation. Micron sized powders, nanopowders, core-shell and multilamellar vesicles structures besides powders with specific morphologies have been synthesized in the group. Besides, thick and thin films or patterns can be obtained on flat or 3D structured substrates.

### Specific hydrogen- related expertise & research topics

For the past decade the research has been focusing on materials for galvanic cells (lithium and sodium ion batteries as well as Li-S batteries). For several years, the group's research activities into materials for catalytic CO<sub>2</sub> conversion and H<sub>2</sub> generation are growing fast. **Regarding H<sub>2</sub> generation, the group is currently focusing on design and synthesis of materials for**

- **Photocatalytic hydrogen generation:** stabilizing ZnO:Al as photocatalyst, understanding the interplay between synthesis, formation of defects and catalytic function
- **Photoelectrochemical hydrogen generation:** design and synthesis of thin films and powder-based materials with catalytic activity in the photoelectrochemical water splitting
- **(PEM) electrolysis:** design and synthesis of catalysts for hydrogen and oxygen evolution reactions in PEM electrolysis cells

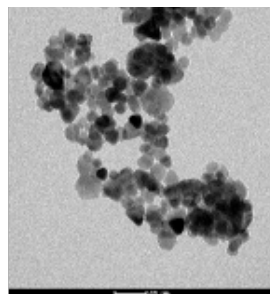

TEM image of ZnO:Al  
 nanoparticles

Photograph of  
 thin-film  
 photoactive cathode

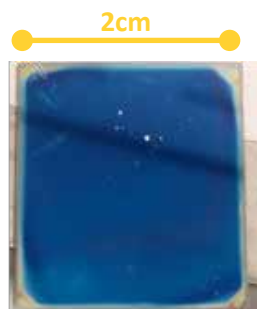



### Available equipment/tools

- Nanolabs up to risk level 3 (high risk)
- Solution synthesis equipment (solvo-thermal reactors with sampling possibilities, Schlenk lines, etc)
- High temperature furnaces and RTP
- High-speed centrifuge (max. 20 000g)
- Tape-casting, Spin-coater, dip-coater and spray-coater
- Gloveboxes (N<sub>2</sub> and Ar)
- Potentiostats and electrochemical cells
- Gas chromatography
- N<sub>2</sub> sorption - BET
- XRD
- SEM and TEM
- FTIR and Raman, UV-Vis spectroscopy
- Mass spectrometry

### Participating in FL/B/EU funded projects with H<sub>2</sub> related research:

- Bilateral BOF PhD scholarship UHasselt – UNamur of Alessandra Piras, working on photocatalytic water splitting with AZO, partners: M.K. Van Bael, An Hardy, and Peter Adriaensens (UHasselt), Carmela Aprile and Luca Fusaro (UNamur). Also in collaboration with Sammy Verbruggen, Pegie Cool and Silvia Lenaerts at UAntwerp.
- Grand challenges BOF project UHasselt, Clean H<sub>2</sub>, partnering Dirk Vanderzande, An Hardy, Koen Vandewal, Momo Safari, and Robert Malina of UHasselt.
- SYN-CAT: Synergetic design of catalytic materials for integrated photo- and electrochemical CO<sub>2</sub> conversion processes; Funding: VLAIO-MOT
- BE-HYFE: BE-HyFE – Belgian Hydrogen Fundamental Expertise; ETF project
- T-REX: On the transition to more Renewable Energy in power-to-X applications: ETF project
- LUMEN: Zonlicht als brandstof voor duurzame chemische processen; Interreg EMR project
- SPOTLIGHT: SPOTLIGHT solar fuels”: a disruptive photonic technology to create carbon neutral fuels: Horizon 2020 project
- Green Hydrogen Lab: Relance Vlaamse Veerkracht project

## Main relevant publications

- Eutectogels: A New Class of Solid Composite Electrolytes for Li/Li-Ion Batteries, B. Joos, T. Vranken, W. Marchal, M. Safari, M. K. Van Bael, and A. T. Hardy; **Chemistry of Materials**, 2018, 30 (3), 655–662.
- Reduced Na<sub>2+x</sub>Ti<sub>4</sub>O<sub>9</sub>/C Composite: A Durable Anode for Sodium-Ion Batteries, D. De Sloovere, M. Safari, K. Elen, J. D'Haen, O. A. Drozhzhin, A. M. Abakumov, M. Šimėnas, J. Banyš, J. Bekaert, B. Partoens, M. K. Van Bael, and A. Hardy, **Chemistry of Materials**, 2018, 30 (23), pp 8521–8527.
- Remarkable lowering in the synthesis temperature of LiMn<sub>2</sub>O<sub>4</sub> via citrate solution-gel synthesis facilitated by ethanol, Maino, G.; Carleer, R.; Marchal, W.; Bonneux, G.; Hardy, A.; Van Bael, M.K. **Dalton Transactions**, 2017 46 (43) 14934-14946
- van den Ham, Evert Jonathan; Elen, Ken; Bonneux, Gilles; Maino, Giulia; Notten, P. H. L.; Van Bael, Marlies K. & Hardy, An (2017). 3D indium tin oxide electrodes by ultrasonic spray deposition for current collection applications. **Journal of Power Sources**, 348, p. 130-137
- Effect of annealing atmosphere on LiMn<sub>2</sub>O<sub>4</sub> for thin film Li-ion batteries from aqueous chemical solution deposition, G. Maino, J. D'Haen, F. Mattelaer, C. Detavernier, A. Hardy, M.K. Van Bael, **J. Mater. Chem. A**, 2016, 4, pp 18457-18469.
- Ultrasonic spray deposition of metal oxide films on high aspect ratio microstructures for 3D all-solid-state Li-ion batteries ; E. Jonathan van den Ham, Sven Gielis, Marlies Van Bael, An Hardy; **ACS Energy Letters**, 2016 1, p.1184-1188
- Chemical Composition of an Aqueous Oxalato-/Citrate-VO<sub>2</sub><sup>+</sup> Solution as Determinant for Vanadium Oxide Phase Formation. PEYS, Nick; Maurelli, Sara; REEKMANS, Gunter; ADRIAENSENS, Peter; De Gendt, Stefan; HARDY, An; VAN DOORSLAER, Sabine & VAN BAEL, Marlies **Inorganic Chemistry**, (2015) 54 (1), p. 69-78
- Factors influencing the conductivity of aqueous sol(ution)-gel processed Al-doped ZnO films; H. Damm, P. Adriaensens, C. De Dobbelaere, B. Capon, K. Elen, J. Drijkoningen, B. Conings, J. Manca, J. D'Haen, C. Detavernier, P.C.M.M. Magusin, J. Hadermann, A. Hardy, M.K. Van Bael, **Chemistry of Materials** 26(20) (2014) 5839-5851

## International collaborations:

- TNO Eindhoven, The Netherlands, dr. Pascal Buskens

## Contact persons:

An Hardy

<https://www.uhasselt.be/fiche?email=an.hardy>

Email: [an.hardy@uhasselt.be](mailto:an.hardy@uhasselt.be)

Marlies K. Van Bael

<https://www.uhasselt.be/fiche?email=marlies.vanbael>

Email: [marlies.vanbael@uhasselt.be](mailto:marlies.vanbael@uhasselt.be)

## *UHasselt: Institute for Materials Research (IMO-IMOMECC) / Group of Electrochemical Engineering*

UHasselt, Engineering Technology  
Imec Associated Laboratory

### General expertise of the research group

- Study of equilibrium and out-of-equilibrium behaviour in electrochemical systems such as batteries, fuel cells, electrolyzers, etc. In particular, reaction kinetics and charge transport in solid and liquid phases.
- Porous electrode engineering
- Physics-based modeling of electrochemical cells

### Specific hydrogen- related expertise & research topics

One PhD student (Subir Paul) has started his research in the context of CleanH<sub>2</sub> BOF project in which the focus of the group would be is on

- Engineering of the membrane-electrode assembly for optimal and long-life performance
- Characterization of the polarization and side reactions in PEM electrolyzers
- Development of diagnostic methods for tracking the state-of-health of electrolyser

### Available equipment/tools update

- Water electrolyzer setup with 5cm<sup>2</sup> electrode cross section.
- Galvanostat/potentiostat
- Helium pycnometer
- Blade coater
- Calendering machine

### Participating in FL/B/EU funded projects with H<sub>2</sub> related research

- CLEANH<sub>2</sub>, Fundamental Research in Solar-driven Hydrogen Generation using Earth-abundant Catalysts and Durable Hybrid Perovskites as Light Absorbers. Funding agency: BOF project. UHasselt research groups, 5 principal Investigators. 2021-2025.



Battery labs at EnergyVille EnergyVille combines the expertise of four partners (KU Leuven, VITO, imec and UHasselt) and in that way offers specialized knowledge of all parts of the energy system and the integration of all systems together.

#### Main relevant publications

- Poster presentation at 'Hydrogen research event: 12/5/2022, Antwerp Expo, 'Design, development, fabrication, and characterization of a proton exchange membrane water electrolyzer,' S. Paul, A. Hardy, K. Vandewal, M. Safari.
- "Non-uniform distribution of current in plane of large area lithium electrodes," S. Yari, M. K. Van Bael, A. Hardy, M. Safari, *Batteries and Supercaps* (2022) 5(10).
- "Demystifying Charge Transport Limitations in the Porous Electrodes of Lithium-Ion Batteries," H. Hamed, S. Yari, J. D'Haen, F. Uwe Renner, N. Reddy, A. Hardy, M. Safari, *Advanced Energy Materials* (2020)10(47): 2070193.
- "Constructive versus Destructive Heterogeneity in Porous Electrodes of Lithium-Ion Batteries," S. Yari, H. Hamed, J. D'Haen, M. K Van Bael, F. Uwe Renner, A. Hardy, M. Safari, *ACS Applied Energy Materials* (2020) 3(12): 11820-11829.

#### Contact persons

Prof. dr. Momo Safari

<https://www.uhasselt.be/fiche?email=momo.safari>

Email: [momo.safari@uhasselt.be](mailto:momo.safari@uhasselt.be)

## *UHasselt: Institute for Materials Research (IMO-IMOMEc) / Hybrid Halide Perovskites for Energy Applications (HyMaD)*

Hasselt University, Science faculty, Chemistry  
Imec Associated Laboratory

### General expertise of the research group

The research institute Imo-Imomec at UHasselt is a joint initiative of imec and UHasselt with a joint expertise. About half of our research activity is related to thin film photovoltaic, including CIGS, organic, inorganic, hybrid perovskites PV. The expertise of our 3 divisions (Chemistry, Physics and Engineering Technology) is brought together and use towards fundamental research, applied research and device engineering of (semi-)conductor materials. It covers synthesis, structural characterisation, material processing and device physics. The institute has developed many original contributions to the chemistry and physics of conjugated small molecules and polymers including development of novel synthesis routes and has built up an internationally recognized strong reputation in the domain. Since 2016, the synthesis activities include ammonium functionalized chromophores for integration in 2D layered Hybrid Organic Inorganic Perovskites (HOIP) (Dirk VANDERZANDE (UHasselt), Laurence LUTSEN (Imec-imomec)).

### Specific hydrogen- related expertise & research topics

- Development of high-efficiency and stable hybrid perovskite (3D and 2D layered) and organic semiconductor molecules for application in PEC and PV+EC.
- Structural characterisation
- Thin film morphology

### Available equipment/tools

- Fully equipped organic and hybrid materials synthesise and spectroscopic characterisations including Schlenk lines to work under inert conditions.
- Liquid NMR
- Solid state NMR to evaluate both amorphous and crystalline phases and molecular miscibility of blends at the nm scale.
- State-of-the-art glovebox systems to produce perovskite materials under inert conditions.
- Solvent purification system connected to the glovebox
- MALDI-TOF
- Vacuum sublimation system for small organic molecules
- FTIR, Raman, UV-Vis spectroscopy
- SEM and TEM
- etc

### Participating in FL/B/EU funded projects with H<sub>2</sub> related research

- CLEANH<sub>2</sub>, Fundamental Research in Solar-driven Hydrogen Generation using Earth-abundant Catalysts and Durable Hybrid Perovskites as Light Absorbers. Funding agency: BOF project. UHasselt research groups, 5 principal Investigators. 2021-2025.
- PROCEED, Hybrid Perovskites as Material Platform for Conversion, Emission and Detection of Light. Funding agency: FWO, SBO project. UHasselt, UGent, KULeuven, UAntwerpen and IMEC as the coordinator of the project. 2020-2024
- FWO senior research project. A fundamental study of energy and charge transfer processes in low dimensional organic-inorganic hybrid perovskites. Funding agency: FWO. PI: Dirk Vanderzande. FWO 019-16
- FWO PhD fellowship Martijn Mertens. 2D perovskite-induced self-organization of conjugated chromophores for efficient and stable optoelectronic applications. 01/01/2018-31/12/2021
- FWO PhD fellowship Arthur Maufort. Self-assembly of organic donor-acceptor complexes within a perovskite structure: a fundamental study of the relationship between optoelectronic and structure properties. 01/11/2020-31/10/2024



### International collaborations

- TUDelft, Prof. Dr. Ferdinand Grozema, Time-resolved Microwave Conductivity
- Arizona State University, Prof. Dr. Brent Nannenga, Cryo Electron Microscopy
- CSEM, Dr. Brett Kamino and Dr. Björn Niesen, large area perovskite solar cells
- Solaronix, Dr. David Martineau, large area perovskite solar cells
- University of Toronto, Dr. Amin Morteza Najarian (Sargent group), Electro Optical Modulation
- Rijksuniversiteit Groningen, Prof. Dr. Maria Antonietta Loi, photophysics and solar cells
- Victoria University of Wellington, Dr. Kai Chen, femtosecond luminescence
- TUEindhoven, Prof. Dr. René Janssen, in-situ absorption spectroscopy during spin-coating

## Main relevant publications

- 2D layered perovskite containing functionalised benzothieno-benzothiophene molecules: formation, degradation, optical properties and photoconductivity. Van Gompel, Wouter T. M.; Herckens, Roald; Denis, Paul-Henry; Mertens, Martijn; Gelvez-Rueda, Maria C.; Van Hecke, Kristof; Ruttens, Bart; D'Haen, Jan; Grozema, Ferdinand C.; Lutsen, Laurence; Vanderzande, Dirk. *Journal of Materials Chemistry C: Materials for Optical and Electronic Devices*, 2020, 8(21), 7181-7188.
- Inducing charge separation in solid-state two-dimensional hybrid perovskites through the incorporation of organic charge-transfer complexes. Gelvez-Rueda, Maria C.; Van Gompel, Wouter T. M.; Herckens, Roald; Lutsen, Laurence; Vanderzande, Dirk; Grozema, Ferdinand C. *Journal of Physical Chemistry Letters*, 2020, 11(3), 824-830.
- Lead-Halide Perovskites Meet Donor-Acceptor Charge-Transfer Complexes. Marchal, Nadege; Van Gompel, Wouter; Gelvez-Rueda, Maria C.; Vandewal, Koen; Van Hecke, Kristof; Boyen, Hans-Gerd; Conings, Bert; Herckens, Roald; Maheshwari, Sudeep; Lutsen, Laurence; Quarti, Claudio; Grozema, Ferdinand C.; Vanderzande, Dirk; Beljonne, David. *Chemistry of Materials*, 2019, 31(17), 6880-6888.
- Low-Dimensional Hybrid Perovskites Containing an Organic Cation with an Extended Conjugated System: Tuning the Excitonic Absorption Features. Van Gompel, Wouter T. M.; Herckens, Roald; Van Hecke, Kristof; Ruttens, Bart; D'Haen, Jan; Lutsen, Laurence; Vanderzande, Dirk. *ChemNanoMat*, 2019, 5(3), 323-327.
- Towards 2D layered hybrid perovskites with enhanced functionality: introducing charge-transfer complexes via self-assembly. Van Gompel, Wouter T. M.; Herckens, Roald; Van Hecke, Kristof; Ruttens, Bart; D'Haen, Jan; Lutsen, Laurence; Vanderzande, Dirk. *Chemical Communications*, 2019, 55(17), 2481-2484.
- Layered hybrid organic-inorganic perovskite materials. Lutsen, Laurence; Vanderzande, Dirk. IMEC VZW, Belg.; Universiteit Hasselt. Jan 31, 2019. Patent WO 2019020612A1.
- Multi-layered hybrid perovskites templated with carbazole derivatives: optical properties, enhanced moisture stability and solar cell characteristics. Herckens, Roald; Van Gompel, Wouter T. M.; Song, Wenya; Gelvez-Rueda, Maria C.; Maufort, Arthur; Ruttens, Bart; D'Haen, Jan; Grozema, Ferdinand C.; Aernouts, Tom; Lutsen, Laurence; Vanderzande, Dirk. *Journal of Materials Chemistry A: Materials for Energy and Sustainability*, 2018, 6(45), 22899-22908.
- Degradation of the Formamidinium Cation and the Quantification of the Formamidinium-Methylammonium Ratio in Lead Iodide Hybrid Perovskites by Nuclear Magnetic Resonance Spectroscopy. Van Gompel, Wouter T. M.; Herckens, Roald; Reekmans, Gunter; Ruttens, Bart; D'Haen, Jan; Adriaensens, Peter; Lutsen, Laurence; Vanderzande, Dirk. *Journal of Physical Chemistry C*, 2018, 122(8), 4117-4124.

## Contact persons

Dirk Vanderzande (UHasselt/imec-imomec)  
<https://www.uhasselt.be/fiche?email=dirk.vanderzande>  
Email : [dirk.vanderzande@uhasselt.be](mailto:dirk.vanderzande@uhasselt.be)

Laurence Lutsen (Imec-Imomec)  
<https://www.uhasselt.be/fiche?email=laurence.lutsen>  
Email: [Laurence.lutsen@uhasselt.be](mailto:Laurence.lutsen@uhasselt.be) / [laurence.lutsen@imec.be](mailto:laurence.lutsen@imec.be)

## UHasselt: Institute for Materials Research (IMO-IMOMEC) / Organic Opto-Electronics Research (OOE)

Hasselt University, Faculty of Sciences, Materials Physics  
 Imec Associated Laboratory

### General expertise of the research group

The organic opto-electronics research group has the aim to solve fundamental questions in organic, hybrid and molecular electronics with relevance in opto-electronic devices such as OLEDs, sensors, solar cells and photovoltaic systems. The group is led by Prof. Dr. Ir. Koen Vandewal, who is well known for his seminal work on the characterization and description of charge-transfer states at organic interfaces. The groups expertise lies in the fabrication and characterization of thin film devices based on organic and hybrid perovskite materials, as well as advanced device characterization and device physics.

### Specific hydrogen- related expertise & research topics

- Integration of organic and perovskite PV-elements with electrochemical cells.
- Engineering of photovoltaic interfaces.

### Available equipment/tools

- Glovebox with spincoater and thermal evaporator for sample and device preparation
- AM1.5g solar simulator
- Steady-state spectroscopy: UV/Vis/NIR transmission/reflection/absorption and photocurrent spectroscopy (350 nm – 2500 nm), emission (photoluminescence/electroluminescence/thermal) spectroscopy (350 nm – 20 μm)
- Photothermal deflection and photoluminescence excitation spectroscopy with wavelength tuneable laser excitation (450 – 650 nm & 900 – 1300 nm)
- Time gated iCCD for time resolved spectroscopy (400 – 800 nm). 2 ns minimum gating time

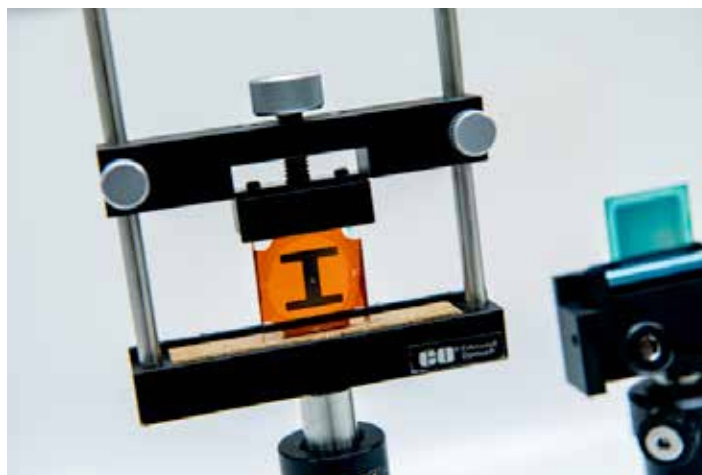



### International collaborations

- TU Dresden (device physics and engineering)
- Stanford University (Synchrotron x-ray analysis)

### Participating in FL/B/EU funded projects with H<sub>2</sub> related research

- CLEANH<sub>2</sub> – Fundamental Research in Solar-driven Hydrogen Generation using Earth-abundant Catalysts and Durable Hybrid Perovskites as Light Absorbers, BOF.
- ConTROL – Charge-transfer states for high performance organic electronics, ERC Consolidator Grant
- Joint FWO project with HyMAT - Self-assembly of organic donor-acceptor complexes within the confinement of a perovskite lattice: a fundamental study of the relation between structure and opto-electronic properties. (R-11232)

### Main relevant publications

- Emissive and charge-generating donor–acceptor interfaces for organic optoelectronics with low voltage losses. S. Ullbrich, J. Benduhn, X. Jia, V. C. Nikolis, K. Tvingstedt, F. Piersimoni, S. Roland, Y. Liu, J. Wu, A. Fischer, D. Neher, S. Reineke, D. Spoltore, K. Vandewal. *Nature materials*, 2019, 18.5: 459-464.
- Lead-Halide Perovskites Meet Donor–Acceptor Charge-Transfer Complexes. N. Marchal, W. Van Gompel, M. C. Gélvez-Rueda, K. Vandewal, K. Van Hecke, H-G. Boyen, B. Conings, R. Herckens, S. Maheshwari, L. Lutsen, C. Quarti, F. C. Grozema, D. Vanderzande, D. Beljonne. *Chemistry of Materials*, 2019, 31(17), 6880-6888.
- High voltage vacuum-deposited CH<sub>3</sub>NH<sub>3</sub>PbI<sub>3</sub>–CH<sub>3</sub>NH<sub>3</sub> PbI<sub>3</sub> tandem solar cells. J. Ávila, C. Momblona, P. Boix, M. Sessolo, M. Anaya, G. Lozano, K. Vandewal, H. Míguez, H. J. Bolink. *Energy & Environmental Science*, 2018, 11(11), 3292-3297.
- Intrinsic non-radiative voltage losses in fullerene-based organic solar cells. J. Benduhn, K. Tvingstedt, F. Piersimoni, S. Ullbrich, Y. Fan, M. Tropiano, K. A. McGarry, O. Zeika, M. K Riede, C. J. Douglas, S. Barlow, S. R. Marder, D. Neher, D. Spoltore, K. Vandewal. *Nature Energy*, 2017, 2(6), 17053.
- Reducing voltage losses in cascade organic solar cells while maintaining high external quantum efficiencies. V. C. Nikolis, J. Benduhn, F. Holzmueller, F. Piersimoni, M. Lau, O. Zeika, D. Neher, C. Koerner, D. Spoltore, K. Vandewal. *Advanced Energy Materials*, 2017, 7(21), 1700855.

### Contact persons

Koen Vandewal

<https://www.uhasselt.be/fiche?email=koen.vandewal>

Email: [koen.vandewal@uhasselt.be](mailto:koen.vandewal@uhasselt.be)

## UGent: Dept. Solid State Sciences - Research group COCOON

### Ghent University, Faculty of Sciences

#### General expertise of the research group:

The research group COCOON is part of the Department of Solid State Sciences and is led by Christophe Detavernier and Jolien Dendooven. Our research is directed at developing and understanding thin film materials within a context of applications relevant to society. We develop thin films and nanomaterials and systematically study their properties governed by their composition, structure, and surface and interface nature. We are particularly interested in (1) physical phenomena that occur at surfaces and interfaces during thin film growth or electrochemical energy conversion reactions, (2) solid state reactions that occur at the nanoscale, and (3) ion transport in solid state nanoscale systems that are relevant to battery and memory applications. Understanding these fundamental aspects provides the necessary foundation for optimizing deposition processes and developing materials with an improved functionality for the targeted applications. Important research topics include

- **Atomic layer deposition** for ultrathin coatings, surface engineering and conformal coating of nanostructured materials.
- **In-situ characterization** of thin films during deposition/annealing treatments.
- **Combinatorial thin film research** for fast screening of composition-dependent properties of binary, ternary or even quaternary mixtures.

#### Specific hydrogen- related expertise & research topics:

The COCOON group has a strong track record in investigating thin film materials for applications in microelectronics and battery technology. Since several years, the group is expanding its expertise in thin film technology to applications in electrocatalysis:

- Atomic layer deposition (ALD) of electrocatalysts for hydrogen and oxygen evolution reactions: metal nanoparticles, oxides, phosphates and sulphides with controllable composition and dimensions.
- ALD for tailoring electrochemical interfaces, e.g. passivation layers for photoelectrodes or stabilizing layers to prevent catalyst degradation.
- Combinatorial magnetron sputtering of alloy thin film libraries for catalyst composition screening.

#### International collaborations:

COCOON coordinates the HYCOAT network ([www.hycoat.eu](http://www.hycoat.eu)) with international partners at Aalto University, CIC nanoGUNE, Ruhr-Universität Bochum, TNO, Tyndall National Institute, University of Helsinki & University of Oslo.

### Available equipment/tools:

- Thermal and plasma-enhanced **ALD systems** with several integrated in-situ characterization techniques to monitor surface reactions and film deposition during ALD processes.
- Dedicated setups for the **sputter deposition of combinatorial thin film libraries**. Wafers can be coated with a film that has a uniform thickness and a linear gradient in composition, resulting in a “printed” compositional library of binary, ternary or even quaternary mixtures. In this way, one can easily investigate the properties of >100 different compositions in parallel.
- Several home built systems for **in situ XRD during annealing** under controlled ambient (oxidizing, inert, reducing) offering opportunities to efficiently study the evolution of phase, grain size and phenomena such as crystallization and phase transformations during annealing.
- An **integrated glovebox infrastructure** for thin film deposition onto air-sensitive materials, and for surface and **electrochemical characterization**, all without exposure to air. All gloveboxes are Ar-filled. Several commercial and home-built potentiostat/galvanostat devices are available.
- **UHV cluster tool** consisting of an ALD tool, a scanning probe microscope, an **instrument for XPS** and a vacuum transfer line, which allows for transferring samples between glovebox, deposition and analytical chambers without air exposure.

### Participating in FL/B/EU funded projects with H<sub>2</sub> related research:

- H<sub>2</sub>-MHytic (SBO, Blauwe Cluster, VITO, imec, UGent): H<sub>2</sub> by membrane integrated high surface area nanomesh technology
- SYN-CAT (SBO, VLAIO-MOT, UA, UHasselt, Imec, UGent, VUB): Synergetic design of catalytic materials for integrated photo- and electrochemical CO<sub>2</sub> conversion processes
- TEMPEL (SBO, VLAIO-MOT, VITO, imec, UGent, KULeuven, UA): Temperature assisted water electrolysis

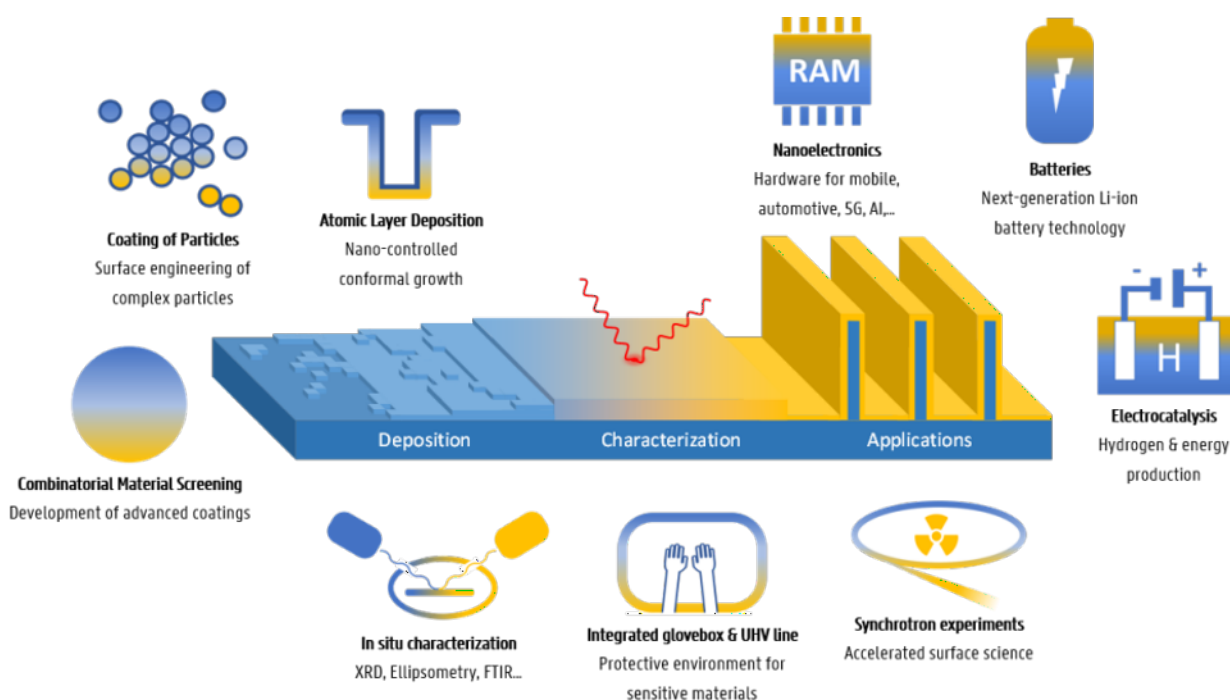

### Main relevant publications:

- Henderick, L.; Dhara, A.; Werbrouck, A.; Dendooven, J.; Detavernier, C. Atomic layer deposition of metal phosphates, *Applied Physics Reviews* 9, 011310 (2022).
- Trompoukis, C.; Feng, J.-Y.; Bosserez, T.; Rongé, J.; Dendooven, J.; Detavernier, C.; Baets, R.; Martens, J. A. ALD Pt nanoparticles and thin-film coatings enhancing the stability and performance of silicon photocathodes for solar water splitting, *Sustainable Energy Fuels*, 2021, Advance Article
- Rongé, J.; Dobbelaere, T.; Henderick, L.; Minjauw, M. M.; Sree, S. P.; Dendooven, J.; Martens, J. A.; Detavernier, C. Bifunctional earth-abundant phosphate/phosphide catalysts prepared via atomic layer deposition for electrocatalytic water splitting, *Nanoscale Advances* 1, 4166 - 4172 (2019).
- Dendooven, J.; Ramachandran, R. K.; Solano, E.; Kurttepli, M.; Geerts, L.; Heremans, G.; Minjauw, M. M.; Dobbelaere, T.; Devloo-Casier, K.; Martens, J. A.; Vantomme, A.; Bals, S.; Portale, G.; Coati, A.; Detavernier, C. Independent tuning of size and coverage of supported Pt nanoparticles using atomic layer deposition, *Nature Communications* 8, 1074 (2017).
- Mattelaer, F.; Bosserez, T.; Rongé, J.; Martens, J. A.; Dendooven, J.; Detavernier, C. Manganese oxide films with controlled oxidation state for water splitting devices through a combination of atomic layer deposition and post-deposition annealing, *RSC Advances* 6, 98337-98343 (2016).
- Rongé, J.; Deng, D.; Sree, S. P.; Bosserez, T.; Verbruggen, S. W.; Singh, N. K.; Dendooven, J.; Roeyfaers, M. B. J.; Taulelle, F.; De Volder, M.; Detavernier, C.; Martens, J. A., Air-based photoelectrochemical cell capturing water molecules from ambient air for hydrogen production, *RSC Advances* 4 (55), 29286-29290 (2014).

### Contact persons:

Louis Sileghem ([Louis.Sileghem@UGent.be](mailto:Louis.Sileghem@UGent.be))

Hydrogen Platform Manager UGent

T +32 496 63 16 01

Prof. Dr. Christophe Detavernier ([Christophe.Detavernier@UGent.be](mailto:Christophe.Detavernier@UGent.be))

Prof. Jolien Dendooven ([Jolien.Dendooven@UGent.be](mailto:Jolien.Dendooven@UGent.be))

<https://www.ugent.be/we/solidstatesciences/cocoon/en>



Materials and  
components  
development

Production of H<sub>2</sub>

## UGent: Laboratory for Chemical Technology

Ghent University, Faculty of Engineering and Architecture

General expertise of the research group:

The Laboratory for Chemical Technology (LCT) integrates chemical science and engineering in its research on catalysis, polymerization, kinetics, reactor design and process design. LCT is part of the Department of Materials, Textiles and Chemical Engineering within the Faculty of Engineering and Architecture at Ghent University in Belgium and member of the Centre for Sustainable Chemistry (CSC) of Ghent University. LCT aims at research excellence and bottom-up innovation in the framework of technological, industrial, and societal challenges.

Specific hydrogen- related expertise & research topics:

- Production of e-fuels
- Economics of e-fuels
- Chemical looping
- Catalytic processes
- ...

Available equipment/tools:

- Lab scale reactors for investigating thermal, catalytic and chemical looping processes
- Chemical looping pilot plant with a production capacity in the order of kg/day
- Catalyst synthesis
- Materials characterization (redox/acid-base properties, porosity, ...)
- Computational infrastructure

International collaborations: -

Participating in FL/B/EU funded projects with H<sub>2</sub> related research:

- MuSE (Energy Transition Fund, 2022-2025, 1 PhD)
- CATCO2RE (SBO, 2018-2021, 3 PhD)
- CO2PERATE (cSBO, 2018-2022, 1 PhD)
- C2O (MOT3 sSBO, 2021-2022, 2 PhD)
- See website: [research.ugent.be](https://research.ugent.be)

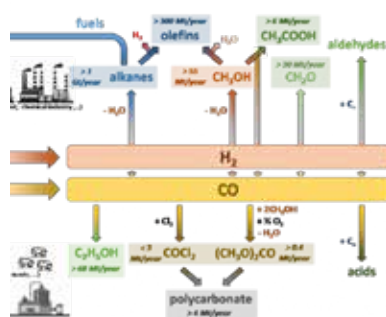
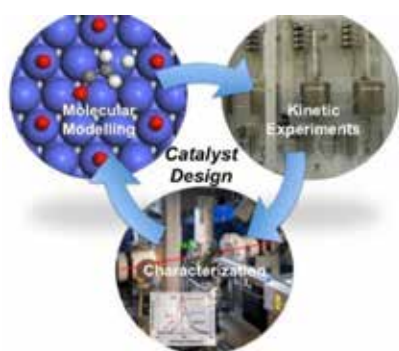

### Main relevant publications:

- See website: [biblio.ugent.be](http://biblio.ugent.be)
- V. Singh, L. C. Buelens, H. Poelman, M. Saeys, G. B. Marin, V. V. Galvita, Intensifying blue hydrogen production by in situ CO<sub>2</sub> utilisation, *Journal of CO<sub>2</sub> Utilization*, 2022, 61, 102014.
- De Vrieze J, Urbina Blanco CA, Thybaut J, Saeys M. Autocatalytic role of molecular hydrogen in copper-catalyzed transfer hydrogenation of ketones. *ACS CATALYSIS*. 2019;9(9):8073–82.
- Van Geem K, Galvita V, Marin G. Making chemicals with electricity. *SCIENCE*. American Association for the Advancement of Science (AAAS); 2019. p. 734–5.

### Contact persons:

Louis Sileghem ([Louis.Sileghem@UGent.be](mailto:Louis.Sileghem@UGent.be))  
 Hydrogen Platform Manager UGent  
 T +32 496 63 16 01

Prof. Kevin Van Geem ([Kevin.VanGeem@UGent.be](mailto:Kevin.VanGeem@UGent.be))  
 Prof. Mark Saeys ([Mark.Saeys@UGent.be](mailto:Mark.Saeys@UGent.be))  
 Prof. Vladimir Galvita ([Vladimir.Galvita@UGent.be](mailto:Vladimir.Galvita@UGent.be))  
 Prof. Joris Thybaut ([Joris.Thybaut@UGent.be](mailto:Joris.Thybaut@UGent.be))  
 Ghent University  
 Laboratory for Chemical Technology  
 Technologiepark-Zwijnaarde 125  
 B-9052 Gent  
 Belgium

## UGent: Particle and Interfacial Technology Group (PaInT)

### Ghent University, Faculty of Bioscience Engineering

#### General expertise of the research group:

The Particle and Interfacial Technology Group (PaInT) is a research group within the Faculty of Bioscience Engineering at Ghent University, which focuses on separation processes for physical-chemical water treatment. The name PaInT stems from the fact that the research is focus on interfacial phenomena and selective separations. The key know-how of the group lies in:

- Industrial water treatment (high-quality applications, cooling & ultrapure water)
- Membrane-based processes (focus on transport phenomena), including reverse and forward osmosis, nano/micro/ultra-filtration, membrane distillation, and electrolysis/electrodialysis.
- Increasing selectivity and fouling resistance of interfaces.
- Resource recovery

#### Specific hydrogen- related expertise & research topics:

- Physical and chemical water treatment for ultrapure water for H<sub>2</sub> production in electrolysis
- Decentralised & alternative energy-powered desalination for ultrapure water
- Link between thermolysis of organic matter, formation of organics acids and H<sub>2</sub>-assisted corrosion phenomena in steam-water cycles (in collaboration with Prof. Kim Verbeken)

#### Available equipment/tools:

- lab- & pilot-scale (ultrapure) water treatment technology
- Mobile IMPROVED pilot-plant infrastructure for on-site water treatment, coupled with process (e.g., steam boiler) simulation and online corrosion measurements
- Lab-scale stacks for conventional electrodialysis and bipolar membrane and mono-selective membrane applications, including automated potentiationstats.
- Lab-scale stacks for electrolysis applications
- Medium and large-size Pilot scale units for electrodialysis applications

#### International collaborations:

- Large academic network throughout Europe, United States, Australia & South-East Africa
- Numerous industrial research collaborations with large multinationals (DOW, Yara, Sabc, DSM, Kurita,...)

### Participating in FL/B/EU funded projects with H<sub>2</sub> related research:

- AquaSPICE (H2020; started 12/2020)
- Improved (Interreg; finished 2020)
- RUSTICA (H2020; started 1/2021)
- BIOSTABLE (SBO; started 10/2020)
- REvivED (H2020, finished 2021)
- Condensate Polishing (ISPT, started 2019)
- MuSE (Energy Transition Fund, started 11/2022)
- Numerous local grants
- See website: [research.ugent.be](https://research.ugent.be)



*Electrodialysis reversal (EDR) pilot plant, capacity: 1.75 m<sup>3</sup>/d product water.*

### Main relevant publications:

- See website: [biblio.ugent.be](https://biblio.ugent.be)

### Contact persons:

Louis Sileghem ([Louis.Sileghem@UGent.be](mailto:Louis.Sileghem@UGent.be))  
Hydrogen Platform Manager UGent  
T +32 496 63 16 01

Prof. Emile Cornelissen ([Emile.Cornelissen@UGent.be](mailto:Emile.Cornelissen@UGent.be))  
Prof. Arne Verliedde ([Arne.Verliedde@UGent.be](mailto:Arne.Verliedde@UGent.be))  
Dr. Leo Gutierrez ([Leonardo.GutierrezGarces@ugent.be](mailto:Leonardo.GutierrezGarces@ugent.be))  
Department of Green Chemistry and Technology  
Particle and Interfacial Technology group (PaInT)  
Coupure Links 653  
B-9000 Ghent  
Belgium





Materials and  
components  
development

Production of H<sub>2</sub>  
Storage of H<sub>2</sub>

## UGent: Center for Ordered Materials, Organometallics & Catalysis

### Ghent University, Faculty of Science

#### General expertise of the research group:

The synthesis of new porous materials and their application in heterogeneous catalysis, adsorption and biomedical systems.

The Center for Ordered Materials, Organometallics and Catalysis (COMOC) is internationally very renowned for the development of novel porous materials, as adsorbents, heterogeneous catalysts, photocatalysts, electrodes for photocatalysis, electrodes for electrocatalysis, materials for sensing and luminescence.

The group typically consists of 1 director (Prof. Pascal Van Der Voort), 5 postdocs, 10-15 PhD students, 5-10 undergraduates and visiting PhD students (interns). They are fully equipped for the characterization and testing of the materials.

#### Specific hydrogen- related expertise & research topics:

- Development and synthesis of novel crystalline highly porous materials
- Development and synthesis of highly porous crystalline polymers
- Storage/Separation of gases in highly porous media (MOFs, COFs)
- Hydrogenation reactions
- Photocatalytic total water splitting
- Z-scheme tandem cells for photocatalysis (heterojunctions)
- Electrocatalysis
- Development of COF-

#### Available equipment/tools:

- GC, HPLC, state of the art sorption equipment (high pressure, low pressure, chemisorption, TPD, TPR, TPD), CHNS elemental analysis, FTIR, FT-Raman, dispersive Raman, UV-VIS, electrocatalytic setups, photocatalytic setups, powder XRD, single crystal XRD, ...

#### Participating in FL/B/EU funded projects with H<sub>2</sub> related research:

- See website: [research.ugent.be](http://research.ugent.be)
- Group website: [www.ugent.comoc.be](http://www.ugent.comoc.be)
- Twitter: @COMOC\_research
- COMOC is active in the Flanders Moonshot Projects on Hydrogen Generation and Hydrogen Storage (MOT-4) with one running project and one project currently being reviewed.

### International collaborations:

COMOC collaborates with the leading international groups on porous materials, heterogeneous catalysis, photo- and electrocatalysis, including prof. Markus Antonietti (MPI-Potsdam), prof. Bettina Lotz (MPI-Stuttgart), prof. Christian Serre (Versailles), prof. Arne Thomas (TU Berlin), prof. Mietek Jaroniec (Kent State Univ, USA), and many others.

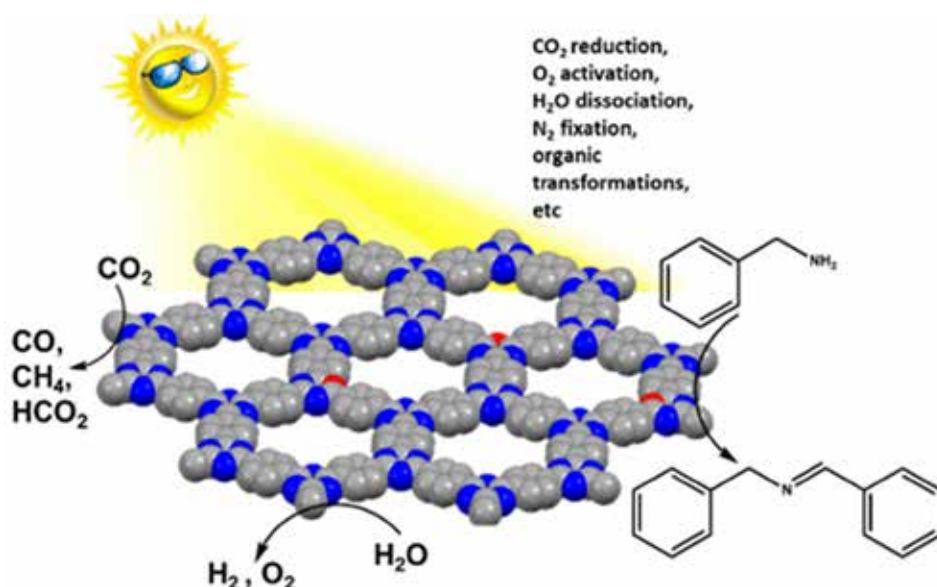

### Main relevant publications:

- See website: [biblio.ugent.be](http://biblio.ugent.be)
- Group website: [www.comoc.ugent.be](http://www.comoc.ugent.be)
- RESEARCH-ID: <http://www.researcherid.com/rid/D-3800-2012>
- ORCID: <http://orcid.org/0000-0002-1248-479X>
- GOOGLE SCHOLAR: <https://scholar.google.be/citations?user=Ddl5E8QAAAAJ&hl=en>
- PUBLONS: <https://publons.com/researcher/1309466/pascal-van-der-voort/>

### Contact persons:

Louis Sileghem ([Louis.Sileghem@UGent.be](mailto:Louis.Sileghem@UGent.be))  
Hydrogen Platform Manager UGent  
T +32 496 63 16 01

Prof. dr. Pascal Van Der Voort ([Pascal.VanDerVoort@UGent.be](mailto:Pascal.VanDerVoort@UGent.be))  
COMOC group  
Department of Chemistry  
Ghent University  
Krijgslaan 281 - building S3 (Campus Sterre)  
9000 Gent  
Tel: +32-9-2644442



Materials and components development; process development; economic aspects

Production of H<sub>2</sub>; general

## VITO: Sustainable chemistry

### VITO – Separation and Conversion Technology (SCT)

#### General expertise of the research group

VITO is a leading European independent research/consultancy center in the areas of cleantech and sustainable development, elaborating solutions for the grand societal challenges of tomorrow: climate change, food security, a sustainable energy supply, the ageing population and scarcity of resources. The business unit of Separation and Conversion Technology is composed of >100 researchers, managers, support staff and students and has organized its strategic research program around the theme 'Sustainable Chemistry' with special focus on (1) process intensification through the integration of separation processes with chemical, microbial, enzymatic or bio-electrochemical conversion processes, and (2) the use of alternative feedstocks, such as CO<sub>2</sub>.

#### Specific hydrogen- related expertise & research topics

- Integration of reaction technology (bio, electrochemical) and separation technologies;
- Expertise in alkaline and PEM fuel cell development and testing;
- Development of low cost and efficient electrodes and membranes;
- The gas diffusion electrodes to be used as air cathodes in MFCs are considered as the state-of-the-art and are currently being optimized for CO<sub>2</sub> conversion processes;
- Activities in the electrosynthesis field with projects on conversion of CO<sub>2</sub> to ethanol, methanol, formic acid and conversion of acids to alcohols and production of ionic liquids.
  
- Techno-economic and life cycle assessment of the hydrogen value chain.
- Energy system modelling, long-term system scenario modelling (2030-2050)

#### Available equipment/tools:

- Fully equipped analytical lab to carry out conventional chemical analyses (volatile fatty acids, gas analyses,...) and degradation studies (AAS, GC, HPLC, GC-MS, GC-TCD...);
- A well-equipped technical lab allowing to construct and assemble new reactor (including monitoring and control) and equipment;
- The research lab on electrochemistry and bioelectrochemistry is well-equipped to carry out simple to very complex experiments. It includes advanced potentiostats and frequency response analysers, oscilloscopes, distribution of diverse gases, facilities for electrode development (manual/automated) and manufacturing, membrane development, engineering support and development, advanced materials characterization.
- A set of advanced electrochemical characterization methodologies is available, with particular expertise on voltammetric and impedimetric measurements.

## International collaborations:

### Participating in FL/B/EU funded projects with H<sub>2</sub> related research:

- Bac-To-Fuel, Bacterial conversion of CO<sub>2</sub> and renewable H<sub>2</sub> into biofuels, H2020 Project ID: 825999
- BIORECO2VER, Biological routes for CO<sub>2</sub> conversion into chemical building blocks, H2020 Project ID: 760431
- LOTER.CO2M, CRM-free low temperature electrochemical reduction of CO<sub>2</sub> to methanol, H2020 Project ID 761093-2
- PERFORM, PowerPlatform: Establishment of platform infrastructure for highly selective electrochemical conversions, H2020 Project ID : 820723
- CATCO2RE, Conversion of solar energy and CO<sub>2</sub> to chemicals and fuels, FWO, VITO/UGent/KUL/VUB
- CO2PERATE, The catalytic conversion of CO<sub>2</sub> to formic acid, Cluster SBO, VITO/UGent/KUL/UA/BEP
- PROCURA, Power to X and carbon capture and utilization roadmap for Belgium, ETF, VITO/IMEC/ Waterstofnet/KUL/VUB/University of Liège
- BREGILAB, Investigation of the practical realisation of further expansion of renewable electricity sources in Belgium, ETF, VITO/KUL/UHasselt/IMEC/KMI
- E2C Interreg Project: Electrons to high value Chemical products
- ELYINTEGRATION Horizon 2020 project “Grid integrated multi megawatt high pressure alkaline electrolyzers for energy applications”, FCH Initiative.
- REselyser FP7 Project “Hydrogen from RES: pressurised alkaline electrolyser with high efficiency”, FCH Initiative
- H<sub>2</sub>-MHytic – VLAIO SBO: H<sub>2</sub> BY MEMBRANE INTEGRATED HIGH SURFACE AREA NANOMESH TECHNOLOGY (VITO, Imec and Ghent University)



### Main relevant publications

- Sánchez, O.G. \*, Birdja, Y.Y. \*, Bulut, M., Vaes, J., Breugelmans, T. and Pant, D, Recent advances in industrial CO<sub>2</sub> electroreduction. *Current Opinion in Green and Sustainable Chemistry*. 2019, 16, 47-56.
- König, M., Vaes, J., Klemm, E. and Pant, D., Solvents and Supporting Electrolytes in the Electrocatalytic Reduction of CO<sub>2</sub>. *iScience*, 2019, 19, p.135.
- Doyen, W., Alvarez Gallego, Y., Stoops, L., Molenbergh, B., Reissner, R., Schiller, G., Guelzow, E., Vaes, J. and Bowen, J.R., 2014. The e-bypass separator: the solution to the inherent problem of alkaline water electrolysis under challenging working conditions. 2014 Membrane Symposium, 08. Sept. 2014, Aachen, Deutschland.
- König, M, Bulut, M., Vaes, J., Klemm, E., Pant, D. 2019. Electrochemical CO<sub>2</sub> conversion. EU patent EP19213008.
- Prato, R.A., Van Vught, V., Eggermont, S., Pozo, G., Marin, P., Fransaer, J. and Dominguez-Benetton, X., 2019. Gas Diffusion Electrodes on the Electrosynthesis of Controllable Iron Oxide Nanoparticles. *Scientific reports*, 9(1), pp.1-11.
- Van Dael, M., Kreps, S., Virag, A., Kessels, K., Remans K., Thomas, D., and De Wilde, F., 2018, Techno-economic assessment of a microbial power-to-gas plant – case study in Belgium, *Applied Energy*, 2015, pp.416-425

### Contact persons:

- Metin Bulut – [metin.bulut@vito.be](mailto:metin.bulut@vito.be)
- Jan Vaes – [jan.vaes@vito.be](mailto:jan.vaes@vito.be)

## Imec: Energy Department

### General expertise of the research group

In the area of energy research imec is active in the whole value chain from basic material research up to the system level. It spans applications from energy generation (Silicon, perovskite and tandem PV cells and modules), energy storage (solid state batteries), energy conversion (power to molecules or electrolysis and fuel cells) and energy systems. For this research, imec builds on its expertise in (semiconductor) electrochemistry, novel materials (electrodes, catalysts, electrolyte), surface functionalisation, design of interfaces, various thin film deposition technologies. Imec also has expertise in characterization of relevant material properties at interfaces and in bulk, and of PV-cells and modules, batteries, electrolyzers and fuel cells.

### Specific hydrogen- related expertise & research topics

- Development of new solid electrolyte materials and membranes with lower resistance, lower thickness and lower gas cross-over.
- Development of new thin electrodes with very large surface area and porosity for ionic conductivity based on controlled and ordered nanostructures to increase current density for thinner MEA.
- Development of novel catalysts and related deposition technologies for higher efficiency and durability
- Realisation of membrane-electrode assemblies (MEA) as basic component for electrolyzers
- Upscaling of all the previous to scales which are industrially relevant
- Study of dynamic behaviour as input for technology-aware modelling
- Integration of PV-elements with electrochemical cells
- Next generation electrolyser using steam or water from the environment (humidity)

### Available equipment/tools:

- Plating and anodization equipment for sizes up to 200 mm
- Thin-film deposition (sputtering, atomic layer deposition, physical evaporation)
- Printing and coating equipment (small size)
- Sol-gel synthesis and analysis
- Ionic conductivity and ionic coupling measurements
- Electrochemical equipment for analysis, synthesis, and characterization
- Single stack electrolyser test cells

### International collaborations: -

### Participating in FL/B/EU funded projects with H<sub>2</sub> related research:

- H<sub>2</sub>-Mhytic – Blauwe Cluster – VITO, imec, UGent: Hydroxyl Exchange Membrane based electrolysis
- PROCURA – ETF – imec, Vito, KUL, VUB, ULiège, WaterstofNet: PV-EC demonstrator and system modeling

Imec's vision is that the electrolysis technology blocks under development have a wide application in conversion of (green) energy to molecules, including CO<sub>2</sub> Capture and Utilization. The following graphic illustrates that point.

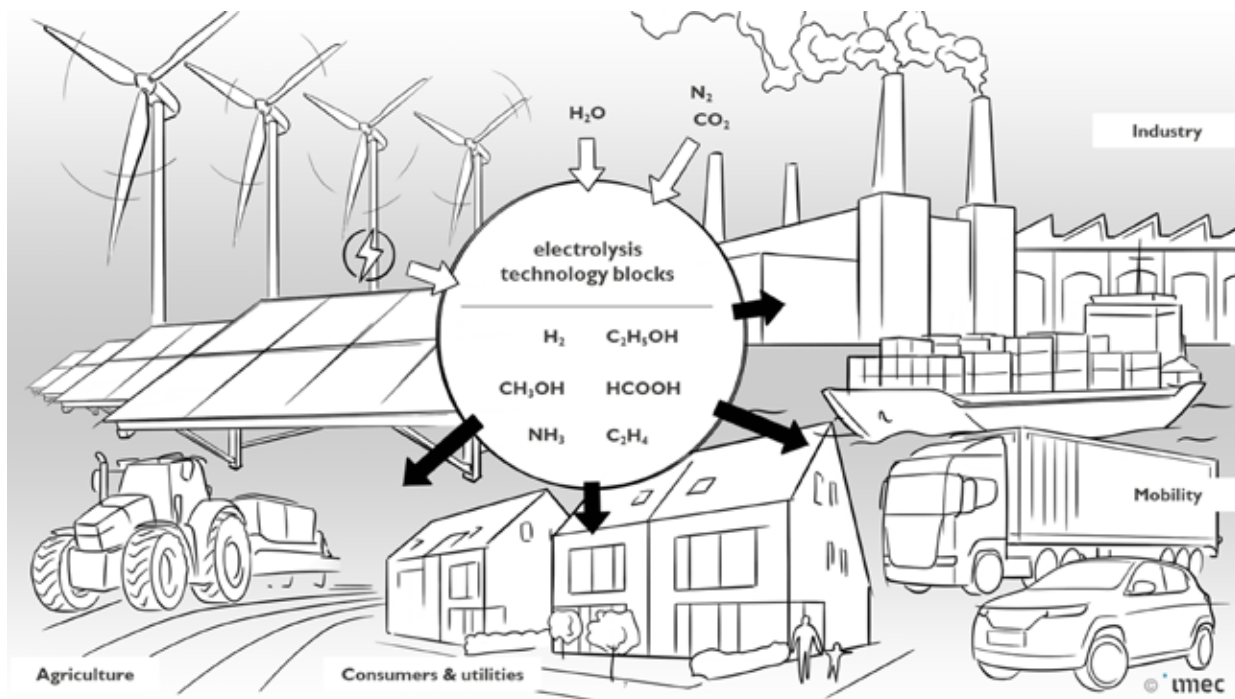

### Main relevant publications

- “Combining High Porosity with High Surface Area in Flexible Interconnected Nanowire Meshes for Hydrogen Generation and Beyond” Stanislaw Zankowski and Philippe M. Vereecken, ACS Appl. Mater. Interfaces, 2018, 10 (51), pp 44634–44644; DOI: 10.1021/acsami.8b15888
- Nanotechnologie: hoe een voetbalveld in een blikje frisdrank onze toekomst kan veranderen | VRT NWS: nieuws (<https://www.vrt.be/vrtnws/nl/2019/03/12/nanotechnologie-hoe-een-voetbalveld-in-een-blikje-frisdrank-onz/>)
- “Redox Layer Deposition of Thin Films of MnO<sub>2</sub> on Nanostructured Substrates from Aqueous Solutions” S.P. Zankowski, L van Hoecke, F Mattelaer, M de Raedt, O. Richard, C. Detavernier, P.M. Vereecken, Chemistry of Materials, 31(13):4805-4816 (2019). IF 9.89.
- “Enhanced Photocatalytic Activity of Nanoroughened GaN by Dry Etching” W. J. Tseng, D. H. van Dorp, R. R. Lieten, B. Mehta, P.M. Vereecken, and G. Borghs, ECS Electrochemistry Letters, 2 (11) H51-H53 (2013).
- “Synthesis of large area carbon nanosheets for energy storage applications”, D. Cott, M. Verheijen, O. Richard, I. Radu, S. De Gendt, S. Van Elshocht, and P.M. Vereecken, Carbon 58, 59–65 (2013); <http://dx.doi.org/10.1016/j.carbon.2013.02.030>.

### Contact persons:

- Philippe Vereecken (technical)
- Jef Poortmans (strategic)
- Bart Onsia (business)

## UGent: Center for Molecular Modeling

### Ghent University, Faculty of Engineering and Architecture/Sciences

#### General expertise of the research group:

The Center for Molecular Modeling focuses on frontier research in six major areas - chemical kinetics in nanoporous materials, computational material research on the nanoscale, spectroscopy, many-particle physics, model development & bio- and organic chemistry. Our multidisciplinary research team is currently composed of about 40 researchers from the Faculties of Sciences (WE05) and Engineering and Architecture (EA17, EA08) of Ghent University.

#### Specific hydrogen- related expertise & research topics:

- Design of Materials for H<sub>2</sub> storage and conversion of chemicals

#### Available equipment/tools:

- Expertise in a very broad range of molecular modeling engines (Gaussian, ADF, MOLPRO, CHARMM, CPMD, CP2K, Orca, VASP,...)
- Developer of own software codes available via <https://molmod.ugent.be/software>, Member of the developer teams of large scale software engines such as LAMMPS, CP2K,...
- Largest user of HPC infrastructure at the Flemish level and pilot user in newly installed HPC clusters

#### International collaborations:-

#### Participating in FL/B/EU funded projects with H<sub>2</sub> related research:

- See website: [research.ugent.be](http://research.ugent.be)



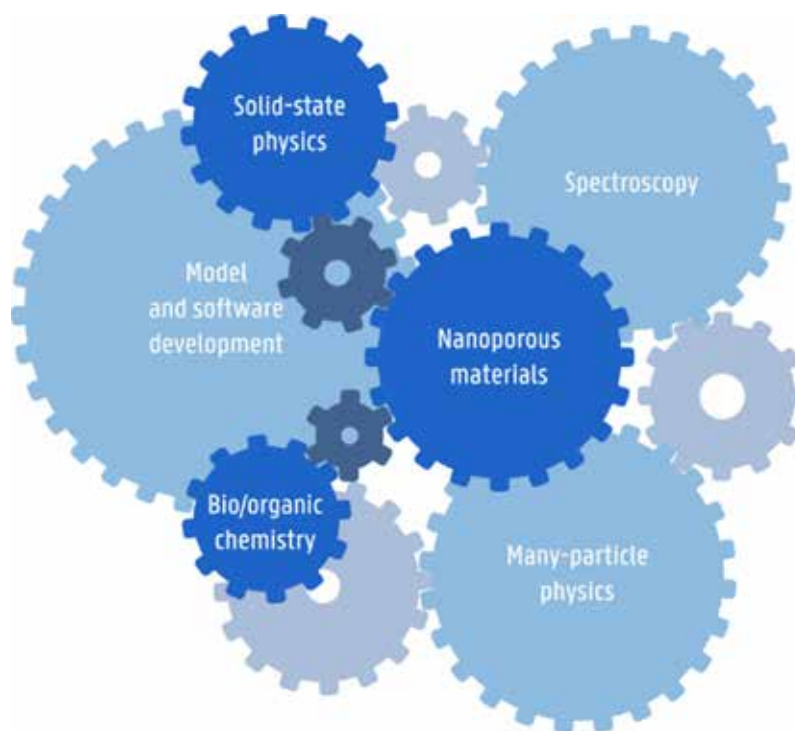

#### Main relevant publications:

- See website: [biblio.ugent.be](http://biblio.ugent.be)
- Vandeputte A, Sabbe M, Reyniers M-F, Van Speybroeck V, Waroquier M, Marin G. Theoretical study of the thermodynamics and kinetics of hydrogen abstractions from hydrocarbons. *JOURNAL OF PHYSICAL CHEMISTRY A. AMER CHEMICAL SOC*; 2007;111(46):11771–86.
- Martínez-Espín JS, De Wispelaere K, Janssens TVW, Svelle S, Lillerud KP, Beato P, et al. Hydrogen transfer versus methylation : on the genesis of aromatics formation in the Methanol-To-Hydrocarbons reaction over H-ZSM-5. *ACS CATALYSIS*. 2017;7(9):5773–80.
- Van Houteghem M, Verstraelen T, Ghysels A, Vanduyfhuys L, Waroquier M, Van Speybroeck V. Analysis of the basis set superposition error in molecular dynamics of hydrogen-bonded liquids : application to methanol. *JOURNAL OF CHEMICAL PHYSICS*. 2012;137(10).

#### Contact persons:

Louis Sileghem ([Louis.Sileghem@UGent.be](mailto:Louis.Sileghem@UGent.be))  
 Hydrogen Platform Manager UGent  
 T +32 496 63 16 01

Prof. Veronique Van Speybroeck ([Veronique.VanSpeybroeck@UGent.be](mailto:Veronique.VanSpeybroeck@UGent.be))  
 Tech Lane Ghent Science Park Campus A  
 Technologiepark 46  
 9052 Zwijnaarde  
 Belgium

## *UGent: Industrial Catalysis and Adsorption Technology (INCAT)*

### Ghent University, Faculty of Engineering and Architecture

#### General expertise of the research group:

The Industrial Catalysis and Adsorption Technology research group (INCAT) focuses mainly on the development of catalysts and adsorbents with a strong focus on renewable resources and environmental management. This involves the catalytic conversion of biomass-derived streams, their upgrading and separation into useful chemicals, with a strong application-oriented goal. This goal is pursued by the many running research projects in collaboration with consortium and industrial partners, including smaller and middle-sized companies in the broader chemical industry.

- Heterogeneous catalysis
- Membrane technologies
- Separation technologies
- Separation and membrane technologies not elsewhere classified
- (Waste)water treatment processes

#### Specific hydrogen- related expertise & research topics:

- catalyzed sodium borohydride hydrolysis (NaBH<sub>4</sub> as storage for hydrogen)

#### Available equipment/tools:

- reactors
- catalyst synthesis
- characterization
- See: <https://incat.ugent.be/infrastructure.html>

#### International collaborations:

- H2Fuel: [www.H<sub>2</sub>-fuel.nl](http://www.H2-fuel.nl)

#### Participating in FL/B/EU funded projects with H<sub>2</sub> related research:

- bilateral projects with H<sub>2</sub>CiF, H<sub>2</sub>Fuel
- See website: [research.ugent.be](http://research.ugent.be)



#### Main relevant publications:

- See website: [biblio.ugent.be](http://biblio.ugent.be)
- B. Van Vaerenbergh, J. Lauwaert, P. Vermeir, J. Thybaut, and J. De Clercq, "Towards high-performance heterogeneous palladium nanoparticle catalysts for sustainable liquid-phase reactions," REACTION CHEMISTRY & ENGINEERING, vol. 5, no. 9, pp. 1556–1618, 2020.

#### Contact persons:

Louis Sileghem ([Louis.Sileghem@UGent.be](mailto:Louis.Sileghem@UGent.be))

Hydrogen Platform Manager UGent

T +32 496 63 16 01

Prof. Jeriffa De Clercq ([Jeriffa.DeClercq@UGent.be](mailto:Jeriffa.DeClercq@UGent.be))

Industrial Catalysis and Adsorption Technology

Telephone number: +32 (0)9 243 25 26

## UGent: Pore-scale Processes in Geo-materials (PProGRes)

### Ghent University, Faculty of Sciences

#### General expertise of the research group:

The research group PProGRes is part of Ghent University's department of Geology and Center for X-ray tomography (UGCT). PProGRes studies the various physical and chemical processes that occur inside porous rocks and sediments. The group specializes in non-destructive 3D and 4D imaging of pore structures and processes in them, from the nano- to macro-scale; mainly using X-ray micro-computed tomography.

#### Specific hydrogen- related expertise & research topics:

- Storage of hydrogen and CO<sub>2</sub> in subsurface rock formations (the latter in the context of Carbon Capture and Storage, e.g. for blue hydrogen). Microscopic (pore-scale) studies of:
  - Multiphase flow in porous rocks (gas and brine natively present)
  - Salt precipitation in porous rocks due brine evaporation in hydrogen/CO<sub>2</sub>
  - Rock alteration processes due to hydrogen-mineral or CO<sub>2</sub>-mineral interactions
  - Relation between geo-mechanics and fluid transport in the subsurface
- Imaging of fluid menisci in porous materials (e.g. hydrogen-water in fuel cells)

#### Available equipment/tools:

- Micro-computed tomography: time-resolved and high-resolution 3D imaging of the internal structure of a sample
- X-ray transparent fluid flow cells (up to 120 bars/100°C)
- High-pressure high-precision piston pumps

#### International collaborations:

On pore-scale fluid transport and interactions in rocks: Université de Pau et Pays de l'Adour (UPPA), Universiteit Hasselt, Heriot-Watt University, TU Eindhoven, Imperial College London, Shell.

Participating in FL/B/EU funded projects with H<sub>2</sub> related research:

- FWO junior research project: “Energy storage in the geological subsurface: impact of salt precipitation in porous media”. Collaboration with H. Derluyn (CNRS/UPPA)
- FWO research project: “VisioFlow: Advanced macro-model generation based on micro-scale visualization experiments of two-phase flow through porous sedimentary rocks”. Collaboration with S. Pop (UHasselt)
- H2020 INFRAIA-grant EXCITE: “Electron and X-ray microscopy Community for structural and chemical Imaging Techniques for Earth materials”

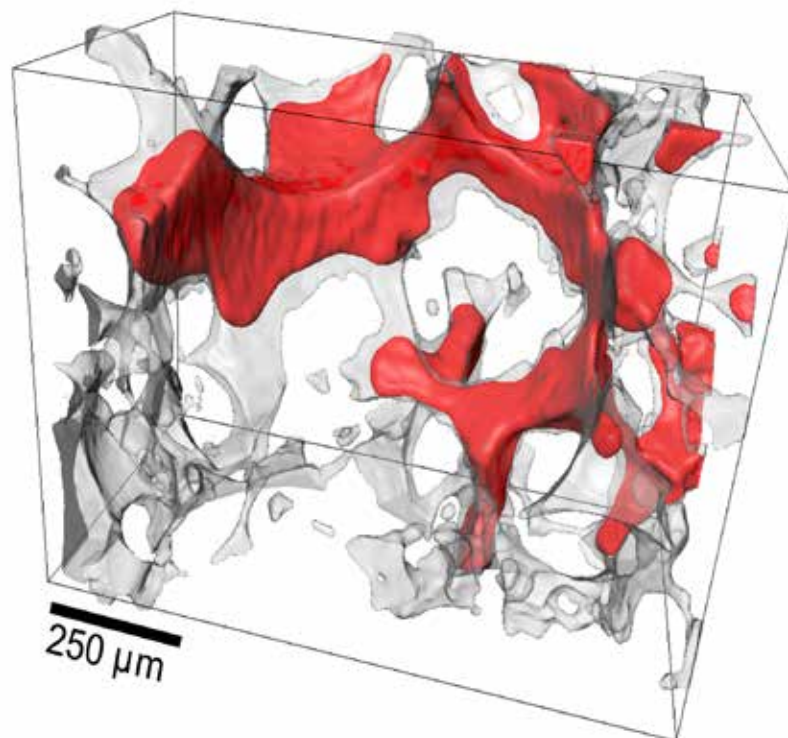

*High-resolution 3D image of fluid menisci in the pores of a rock sample, made by X-ray imaging.*

### Main relevant publications :

- Withers, P. J., Bouman, C., Carmignato, S., Cnudde, V., Grimaldi, D., Hagen, C. K., ... Stock, S. R. (2021). X-ray computed tomography. NATURE REVIEWS METHODS PRIMERS, 1(1).
- Mascini A, Cnudde V, Bultreys T. Event-based contact angle measurements inside porous media using time-resolved micro-computed tomography. JOURNAL OF COLLOID AND INTERFACE SCIENCE. 2020;572:354–63.
- Bultreys T, Lin Q, Gao Y, Raeini AQ, AlRatrouf A, Bijeljic B, et al. Validation of model predictions of pore-scale fluid distributions during two-phase flow. PHYSICAL REVIEW E. 2018;97(5).
- Bultreys T, De Boever W, Cnudde V. Imaging and image-based fluid transport modeling at the pore scale in geological materials : a practical introduction to the current state-of-the-art. EARTH-SCIENCE REVIEWS. 2016;155:93–128.
- Bultreys T, Boone M, Boone M, De Schryver T, Masschaele B, Van Hoorebeke L, Cnudde, V. Fast laboratory-based micro-computed tomography for pore-scale research : illustrative experiments and perspectives on the future. ADVANCES IN WATER RESOURCES. 2016;95:341–51.

### Contact persons:

Louis Sileghem ([Louis.Sileghem@UGent.be](mailto:Louis.Sileghem@UGent.be))  
Hydrogen Platform Manager UGent  
T +32 496 63 16 01

Prof. Veerle Cnudde ([Veerle.Cnudde@UGent.be](mailto:Veerle.Cnudde@UGent.be))  
Prof. Tom Bultreys ([Tom.Bultreys@UGent.be](mailto:Tom.Bultreys@UGent.be))  
Krijgslaan 281, S8  
9000 Gent

## UGent: Mechanics of Materials and Structures (MMS)

### Ghent University, Faculty of Engineering and Architecture

#### General expertise of the research group:

The research group Mechanics of Materials and Structures (MMS) is part of the Department of Materials, Textiles and Chemical Engineering (MaTCh). This group has more than 40 years experience in the design, simulation, testing and inspection of fibre-reinforced composites. In the last decade, also expertise in additive manufactured materials has been developed.

The group has a long-term tradition in numerical simulation and design of composites, in static, impact, fatigue and creep loading conditions. A wide range of experimental test facilities is available for mechanical characterization of materials, and also for NonDestructive Testing (NDT) of materials and components.

#### Specific hydrogen- related expertise & research topics:

The research group has expertise on :

- simulation and design of filament wound composite pressure vessels for hydrogen storage. Investigated topics relate to the vessel design, the effect of fatigue damage during filling/depleting cycles, the instability of the liner (buckling, cracking), the interaction with the metallic inserts, etc.
- NonDestructive Testing (NDT) techniques are developed for inspection of these thick-walled composites. Ultrasound, thermography and shearography techniques are investigated to detect manufacturing defects or in-service damage in the tank, and locate and size the defects.
- micro-mechanical tests to characterize the fibre/matrix interface in composites. Those tests could also be used for ageing tests in the presence of hydrogen
- design and simulation of fuel cell stacks in terms of stiffness, strength and durability (impact/crash, bolting/gaskets)
- topology optimization codes for material choice in thermo-mechanical loading scenarios
- simulation of performance and damage development in flexible transport pipes (typically for offshore applications)

#### Available equipment/tools:

- wide range of lab equipment for static/dynamic/fatigue testing of composite materials and components
- variety of NonDestructive Testing (NDT) techniques for inspection of parts and components
- Finite Element software for mechanical design and simulation (relevant for hydrogen storage tanks, fuel cell engineering, flexible pipelines)
- in-house Topology Optimization codes for multi-material design in thermo-mechanical loading conditions
- micro-mechanical testing facilities for ageing of fibre/matrix interfaces

Main relevant publications:

- <https://research.ugent.be/web/person/wim-van-paepegem-0/publications/en>

Contact persons:

Louis Sileghem ([Louis.Sileghem@UGent.be](mailto:Louis.Sileghem@UGent.be))

Hydrogen Platform Manager UGent

T +32 496 63 16 01

Prof. dr. ir. Wim Van Paepegem ([Wim.VanPaepegem@UGent.be](mailto:Wim.VanPaepegem@UGent.be))

Tech Lane Ghent Science Park – Campus A

Technologiepark-Zwijnaarde 46

B-9052 Gent



## *KU Leuven: Mecha(tro)nic System Dynamics (LMSD) and Composite Materials Group*

KU Leuven, faculties of Engineering Science & Engineering Technology, Departments of Mechanical Engineering & Materials Engineering

### General expertise of the research group

1. experimental identification of material characteristics of fibre-reinforced composites
  2. development of numerical modelling strategies for material properties in a multi-scale context, including micro-, meso- and macro-scale
  3. development of experimental methodologies for the identification and objective quantification of uncertainty and variability in material properties
  4. development of modelling strategies for manufacturing and processing methods of fibre-reinforced composites
  5. numerical modelling strategies for structural components at the micro- and macro-scale, both for metals and fibre-reinforced composites
  6. development of generic numerical formalisms and methodologies for the propagation of uncertainty and variability in structural components
  7. methodologies for the identification and objective quantification of uncertainty and variability in material properties
  8. comprehensive methodologies for the propagation of uncertainty and variability in built-up structures, covering processes, materials and structures
- Specific hydrogen- related expertise & research topics (bullets)

### Application of generic experimental and simulation procedures to characterize pressure vessels, with a focus on reliability:

- filament wound pressure vessels based on axisymmetric geometry, including cylindrical components and dome-like end caps: from micro- to macro-scale [1-8 above]
- $\mu$ CT-scanning procedures and image analysis for the geometrical identification of material structure at the micro-scale (voids and porosities)
- high-pressure vessels ( $10^2$ - $10^3$  bar of differential pressure) for applications in storage of hydrogen in gaseous state
- low-pressure vessels ( $10^{-1}$ - $10^0$  bar of differential pressure) for applications in storage of hydrogen in liquid state, development of efficient design procedures for thin-walled geometries (cylindrical, spherical, toroidal, conical primitives) with membrane stress only and high volumetric efficiency
- topology design and thermo-mechanical analysis of multi-lobe liquid hydrogen fuel storage tanks for application in reusable launchers and blended-wing aircraft
- topology design and thermo-mechanical analysis of storage tanks for transport of hydrogen as cargo payload in aircraft

Participation in FL/B/EU funded projects with H<sub>2</sub> related research:

- SIM ICON project OptiVaS HBC.2019.0070 Optimized pressure vessels through composite Variability Simulation; start 01 Aug 2020 – extended till 31 Jul 2024, co-ordinator: Toyota Motor Europe; partners: Siemens Industry Software, Plastic Omnium, KU Leuven
- SIM SBO project RELFICOM HBC.2017.0321 Reliability of fibre-reinforced composites: materials design & variability; start 01 Jan 2018 – completion 31 Dec 2021, coordinator: KU Leuven ; partners: Toyota Motor Europe, Siemens Industry Software, Plastic Omnium
- FWO doctoral grant strategic basic research, 1SG1523N, Conformable Pressurized Tanks for Hydrogen Storage and Transportation; start 01 Nov 2022 – scheduled till 31 Oct 2026
- VLAIO Baekeland doctoral grant, HBC.2022.0713 Study of the residual stresses in a thermoplastic filament winding process for high-pressure H<sub>2</sub>-storage vessels; 2023-2027, in cooperation with Covess

Illustrative graphic or photograph

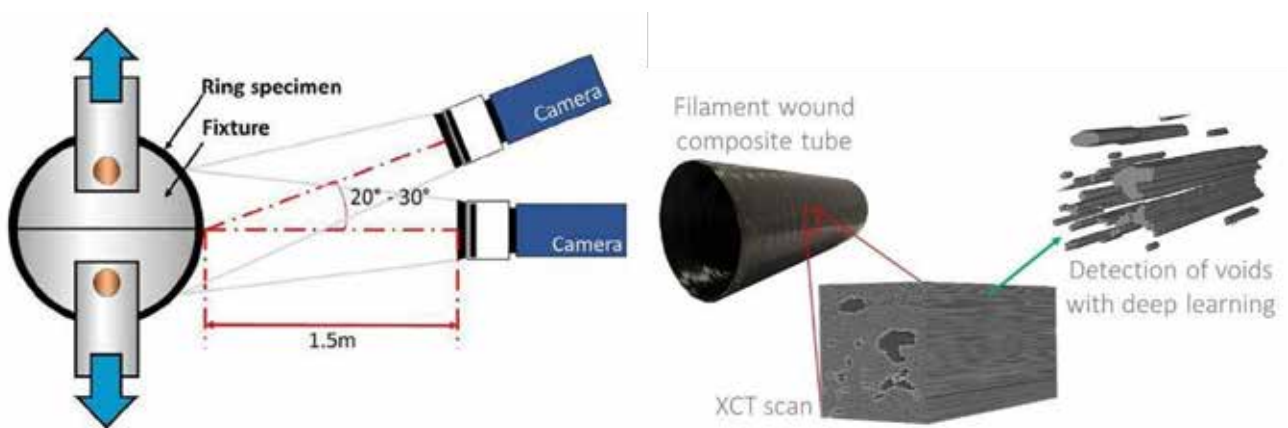

left: split-disk test, right: void characterization in a composite pressure vessel wall via micro-CT

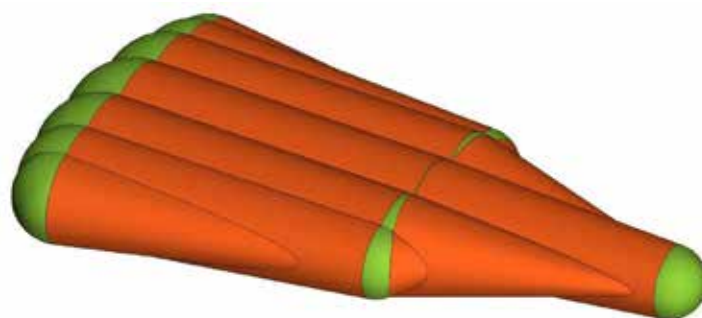

multi-cell tank topology for maximum volumetric efficiency

#### Available equipment/tools:

- composite processing equipment (hot press, autoclave, RTM, infusion)
- drum winder and filament winding machines
- mechanical testing of composites, including split-ring test setup
- damage monitoring tools for mechanical testing (digital image correlation , acoustic emission), C-scan
- SEM and optical microscopy
- $\mu$ CT-scanning equipment (XCT Core Facilities) and image analysis tools
- DIC equipment and image analysis software
- VoxTex model generation for fibre reinforced composites
- generic finite element analysis software

#### International collaborations:

- Toyota Motor Europe (BE)
- Mines ParisTech (FR)
- Mines Douai (FR)
- European Space Agency (ESA)
- Hyviate (DE)

#### Main relevant publications

- Straumit, I., S. V. Lomov and M. Wevers (2015). "Quantification of the internal structure and automatic generation of voxel models of textile composites from X-ray computed tomography data." *Composites Part A* 69: 150-158. doi:10.1016/j.compositesa.2014.11.016.
- Upadhyay, S., A. G. Smith, D. Vandepitte, S. V. Lomov, Y. Swolfs and M. Mehdikhani (2022). Analysis of voids in filament wound composites using a machine-learning-based segmentation tool. 20th European Conference on Composite Materials (ECCM-20): paper 61918.
- Zhao, Y., P. Druzhinin, J. Ivens, D. Vandepitte and S. V. Lomov (2021). "Split-disk test with 3D digital image correlation strain measurement for filament wound composites." *Composite Structures* 263: 113686. <https://doi.org/10.1016/j.compstruct.2021.113686>.
- Zhao, Y., D. Vandepitte and S. V. Lomov (2021). "The effect of delamination on ring specimen failure in the split-disk test with cohesive zone modelling – Comments on the paper: Zhao Y, Druzhinin P, Ivens J, Vandepitte D, Lomov SV. Split-disk test with 3D Digital Image Correlation strain measurement for filament wound composites, *Composite Structures*, 2021, 263:113686 (doi 10.1016/j.compstruct.2021.113686)." *Composite Structures* 277: 114517. <https://doi.org/10.1016/j.compstruct.2021.114617>.
- Niguse Asfew, K., Ivens, J., Moens, D., (2022). "Temperature dependence of thermophysical properties of carbon/polyamide410 composite". *Functional Composite Materials*, 3, Art.No. 8. doi: 10.1186/s42252-022-00036-6 Open Access
- Ypsilantis, K.I., Faes, M., Ivens, J., Lagaros, N., Moens, D. (2022). "An approach for the concurrent homogenization-based microstructure type and topology optimization problem". *Computers & Structures*, 272, Art.No. 106859. doi: 10.1016/j.compstruc.2022.106859
- Malfroy, J., Van Bavel, B., Steelant, J., Vandepitte, D. (2023), "Thin-walled tapered conformable pressurized tanks: Concept and principles", submitted to *Thin-Walled Structures*
- Malfroy, J. (2022) Design and optimization of a tapered multi-bubble tank for hypersonic aircraft, master's thesis dissertation (supervisors D. Vandepitte and J. Steelant)

Contact persons:

- Mechanical Engineering Department, LMSD section:
  - Dirk Vandepitte
  - David Moens
  - Johan Steelant
  - Bert Pluymers
- Materials Engineering Department, Composite Materials Group:
  - Yentl Swolfs
  - Jan Ivens
  - Mahoor Mehdikhani
  - Stepan Lomov
  - Frederik Desplentere

## KU Leuven: Computational Materials Science

KU Leuven, Dept. of Computer Science and Dept. of Materials Engineering

### General expertise of the research group

We develop computational tools to study the behaviour of materials under combined thermo-chemo-mechanical loads. The models are typically implemented into DAMASK, a maintained open source crystal plasticity and multiphysics simulation package (<https://damask.mpie.de>). DAMASK contains physics-based models for elastic and plastic deformation, temperature evolution, fracture, and impurity diffusion.

### Specific hydrogen- related expertise & research topics

- Physics-based constitutive modelling
- Phase field for fracture
- Chemo-mechanics

### Participating in FL/B/EU funded projects with H<sub>2</sub> related research:

- Seed fund (KU Leuven/Aalto University/University of Helsinki):  
Tools to develop materials for the hydrogen economy.

**DAMASK**  
Düsseldorf Advanced Material Simulation Kit

### Available equipment/tools

- Workstation
- DAMASK source code

### International collaborations

- Max-Planck-Institut für Eisenforschung
- Michigan State University
- Infineon Technologies
- Fraunhofer-Institut für Keramische Technologien und Systeme IKTS
- University of Helsinki
- Aalto University

## Main relevant publications

- F. Roters, M. Diehl, P. Shanthraj, P. Eisenlohr, C. Reuber, S. L. Wong, T. Maiti, A. Ebrahimi, T. Hochrainer, H.-O. Fabritius, S. Nikolov, M. Friak, N. Fujita, N. Grilli, K. G. F. Janssens, N. Jia, P. J. J. Kok, D. Ma, F. Meier, E. Werner, M. Stricker, D. Weygand, and D. Raabe. DAMASK – The Düsseldorf Advanced Material Simulation Kit for Modelling Multi-Physics Crystal Plasticity, Damage, and Thermal Phenomena from the Single Crystal up to the Component Scale. *Computational Materials Science* 158:420–478, 2019. (doi:10.1016/j.commatsci.2018.04.030)
- M. Diehl. Review and outlook: mechanical, thermodynamic, and kinetic continuum modeling of metallic materials at the grain scale. *MRS Communications* 7(4):735–746, 2017. (doi:10.1557/mrc.2017.98)
- J. R. Mianroodi, P. Shanthraj, C. Liu, S. Vakili, S. Roongta, N. H. Siboni, N. Perchikov, Y. Bai, B. Svendsen, F. Roters, D. Raabe, and M. Diehl. Modeling and simulation of microstructure in metallic systems based on multi-physics approaches. *npj Computational Materials* 8:93, 2022. (doi:10.1038/s41524-022-00764-0)
- C. C. Tasan, M. Diehl, D. Yan, M. Bechtold, F. Roters, L. Schemmann, C. Zheng, N. Peranio, D. Ponge, M. Koyama, K. Tsuzaki, and D. Raabe. An overview of dual-phase steels: Advances in microstructure-oriented processing and micromechanically guided design. *Annual Review of Materials Research* 45:391–431, 2015. (doi:10.1146/annurev-matsci-070214-021103)

## Contact persons

Prof. Dr.-Ing. Martin Diehl  
Celestijnenlaan 200a - box 2402  
3001 Leuven

## VUB: Department of Chemical Engineering

### Vrije Universiteit Brussel, Faculty of Engineering Sciences

The Department of Chemical Engineering at VUB has extended expertise in separation processes, in particular separation and purification of gas and liquid mixtures by adsorption and chromatography. Advanced experimental techniques (lab on a chip, high-throughput experimentation, ...) are combined with state-of-the-art computer modelling methods, including molecular modelling and computational fluid dynamics, to obtain insight in the fundamental adsorption, diffusion and mass and heat transfer effects. The department has 3 core research topics: adsorptive separation processes, HPLC technology and analysis and microfluidics and microreactors

#### Specific hydrogen- related expertise & research topics

- Adsorption, gas separation, purification and storage
- Hydrogen storage in porous solids
- Hydrogen clathrate formation
- Study of kinetics, uptake and thermodynamics of hydrogen storage
- Experimental assessment and modelling of storage
- CFD modelling for flow field design of electrolyzers and fuel cells
- Know-how on gas sampling, in-line/ on-line / off-line gas analysis

#### Available equipment/tools:

- Ultra-precise (in-house built) gravimetric experimental setup to study H<sub>2</sub>-storage in porous solids: kinetics of storage, uptake capacity, thermodynamics in a broad range of conditions (77K, -30 to 70°C, up to 15 MPa, density measurement, many types of gases)
- Volumetric setup to study gas storage in porous solids
- Breakthrough setup to study purification of hydrogen streams (removal of trace impurities)
- Gas analysis equipment (GC, GC-MS, MS)
- Software tools to simulate H<sub>2</sub>-storage processes

#### International collaborations:

- ITQ Valencia (Prof. F. Rey): micro- and mesoporous solids
- Université de Montpellier (Prof. G. Maurin): molecular modelling of adsorption

### Participating in FL/B/EU funded projects with H<sub>2</sub> related research:

- ARCLATH, H<sub>2</sub> storage in artificial clathrates, VLAIO, Project coordinator: KULeuven, Prof. J. Martens, main partners: KULeuven, UGent, UAntwerpen, VUB.

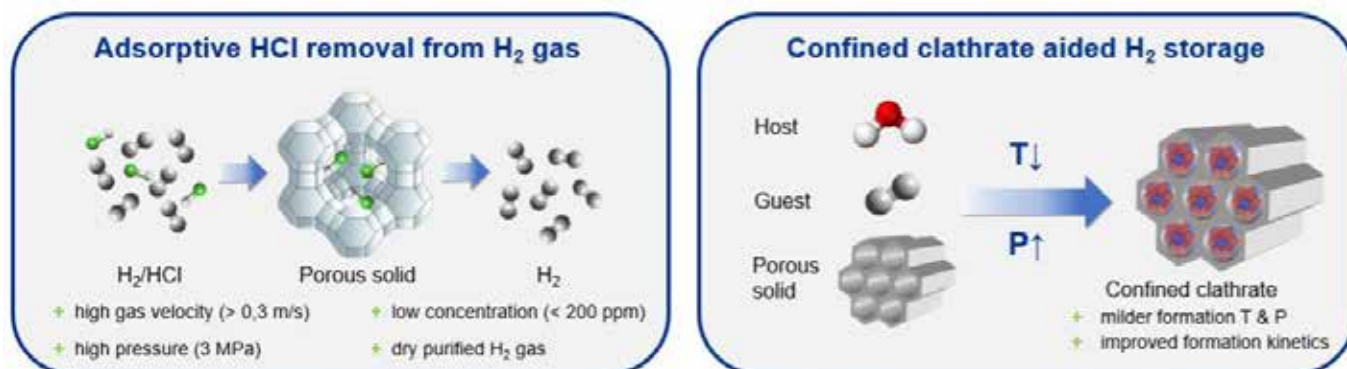

### Main relevant publications

- Gupta, A., Baron, G. V., Perreault, P., Lenaerts, S., Ciocarlan, R.-G., Cool, P., ... , Denayer, J. F. M. (2021). Hydrogen Clathrates: Next Generation Hydrogen Storage Materials. *Energy Storage Materials*, 41, 69–107. <https://doi.org/10.1016/j.ensm.2021.05.044>.
- Sharma, R., Cousin-saint-remi, J., Tiriana, S., Delplancke, M., Pletincx, S., Baert, K., ... Denayer, J. F. M. (2022). Metal-organic framework ZIF-8 for exceptional HCl removal from Hydrogen gas by reaction. *International Journal of Hydrogen Energy*, 47(47), 20556–20560. <https://doi.org/10.1016/j.ijhydene.2022.04.244>
- Sharma, R., Segato, T., Delplancke, M.-P., Terry, H., Baron, G. V., Denayer, J. F. M., & Cousin-Saint-Remi, J. (2020). Hydrogen chloride removal from hydrogen gas by adsorption on hydrated ion-exchanged zeolites. *Chemical Engineering Journal*, 381(August 2019), 122512. <https://doi.org/10.1016/j.cej.2019.122512>.
- De Schepper, P., Danilov, V. A., & Denayer, J. F. M. (2016). Cathode flow field design for nitric oxide/hydrogen fuel cell in cogeneration of hydroxylamine and electricity. *International Journal of Energy Research*, 40(10), 1355–1366. <https://doi.org/10.1002/er.3519>

### Contact persons:

Prof. Joeri Denayer, [joeri.denayer@vub.be](mailto:joeri.denayer@vub.be)

Business developer dr. ir. Marleen Claeys, [marleen.claeys@vub.be](mailto:marleen.claeys@vub.be)



## Sirris: Precision Manufacturing

### Sirris | Advanced Manufacturing

#### General expertise of the research group

Sirris Precision Manufacturing is one of the oldest groups of Sirris and is dedicated towards research and services in the field of advanced manufacturing technologies, and in particular, subtractive manufacturing technologies (e.g. milling, turning, laser ablation) and this in combination with advanced Industry 4.0 practices such as adaptive, data driven machining processes and sensor based manufacturing systems.

#### Specific hydrogen- related expertise & research topics

- Ultrashort pulsed laser texturing which can potentially:
  - Increase specific surface area of Hydrogen Fuel Cell electrodes (up to 1500-fold) and hence increase efficiency.
  - Activate or de-activate parts of the electrode for gas evolving reactions (OER).
  - Produce defects close to the surface to increase wettability and enhance the removal of gas bubbles from the electrodes.
  - Create high emissivity (>0,99) and absorption (>99%) surfaces
- Ultrashort pulsed laser machining which can:
  - Cut and structure thin electrode materials in fast and efficient way.
  - Engineer coating and selectively remove very thin (200-300 nm) noble metal layers without damage to substrate.

#### Available equipment/tools:

- LASEA LS5-1 Femtosecond laser texturing machine
- Keyence vk-x1100 confocal microscope
- COMSOL Thermal modelling & simulation software
- IR Camera & Vacuum tank
- Photospectrometer

#### International collaborations:

Sirris Circular Economy, Coatings and renewable materials (T-ICE)  
Sirris Onshore and Offshore Wind Energy Industry (T-OWI)

### Participating in FL/B/EU funded projects with H<sub>2</sub> related research:

Currently none, but active in ESA GSTP programs to create functional surfaces for space applications and more specifically ultra black surfaces. Recent work by Karsten Lange (Univ. Hannover, Electrode Structuring by Ultrashort Pulsed Lasers: a new tool for the Hydrogen Economy, PhD Thesis, 2019) showed that the same structures are greatly beneficial for Hydrogen applications. This could be potentially a on ground spin-off of space technology developed by Sirris for ESA/Belpo.

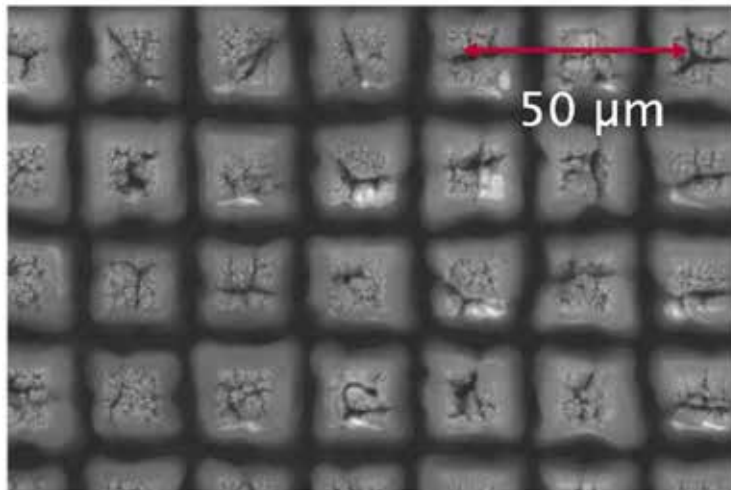

Figure 1: Multiscale structure in Nickel with enormously increase specific surface area, developed for space applications (ESA) but interesting for Hydrogen applications as well.

### Main relevant publications

- Ultrafast Laser Selective Phase Removal for surface modification of nanocomposite materials, J. Han, O. Malek, J. Vleugels, A. Braem, S. Castagne, Optics Express 29 (16), 24834-24845.
- Ultrashort pulsed laser ablation of zirconia-alumina composites for implant applications, J Han, O Malek, J Vleugels, A Braem, S Castagne, Journal of Materials Processing Technology 299, 117335.
- De Tijd "Belgische Onderzoekers lopen mee naar zwaarste zwart" (17/06/2021)

### Contact persons:

Olivier Malek, Senior Engineer, [olivier.malek@sirris.be](mailto:olivier.malek@sirris.be)

Peter ten Haaf, Program Manager, [peter.tenhaaf@sirris.be](mailto:peter.tenhaaf@sirris.be)

## Sirris: Product Development Hub

### Sirris | Composites

#### General expertise of the research group

Product development in Light, Smart and Micro domains.

The Hub combines the expertise of 6 labs (Conception Lab / Fabrication Lab / Micro Lab / Plastics Lab / Hybrids Lab & Smart Lab) to support the companies in the development of innovative products

#### Specific hydrogen- related expertise & research topics

- Simulation of the structural behaviour of high pressure composite vessels
- Definition of optimization of the boss and the laminate structure
- Material characterization from specimens produced out of the right process technology

#### Available equipment/tools:

- Simulations through WoundSim/Abaqus chain and Samcef
- Material characterization via universal tensile machine

#### Participating in FL/B/EU funded projects with H<sub>2</sub> related research:

##### **H2020 THOR**

Partnership: FAURECIA, CETIM & CETIM Grand Est, Air Liquide, RIA, CNRS, NTNU, Sirris

The THOR project aims to develop a cost-effective high-pressure “type 4” thermoplastic composite hydrogen storage vessel for transportation applications.

<https://thor-fch2.eu/>

#### International collaborations:

Only through the EY Project THOR described in the next frame

### Simulation results of an axisymmetric model

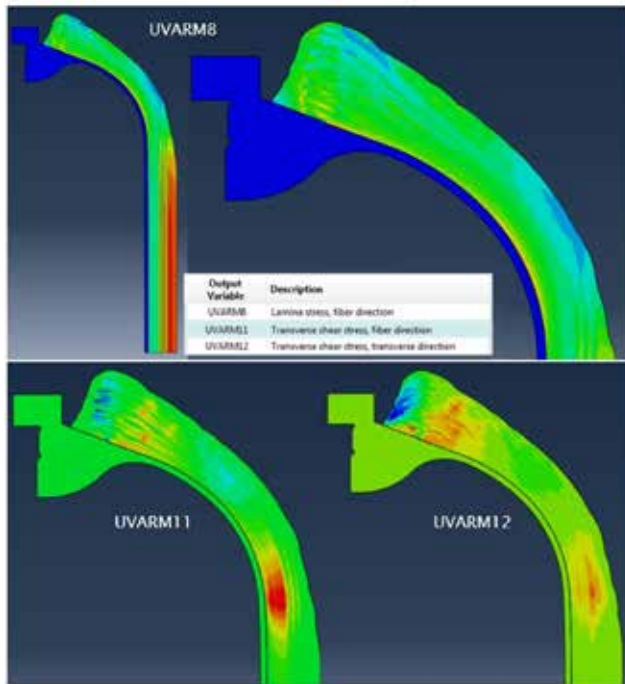

#### Main relevant publications

- Only internal reporting within project THOR

#### Contact persons:

Didier Garray  
[Didier.garray@sirris.be](mailto:Didier.garray@sirris.be)  
+32498919331

## Sirris: Additive Manufacturing

### Sirris | Advanced Manufacturing

#### General expertise of the research group

- Validation of metallic and polymer material for Additive manufacturing in order to use additive manufacturing for increasing the exchange surfaces (specific surface)
- Proof of concepts realisation to test the cells using the potential of AM for iterations

#### Specific hydrogen- related expertise & research topics

- Dense and porous parts in pure copper (produce by EBM)
- Porous material by using design (lattice) and process setting of L-PBF-LB. (SLM)
- Process validation of porous graded Materials by L-PBF-LB (SLS) process
- Conductive track printing on 3D shapes (3D printing + AJP)

#### Available equipment/tools:

- AM metallic materials validation: 2 PBF-LB (SLM) /1 (PBF-EB) (EBM)/1 DED (cladding)
- AM polymer material validation: 1 MJT/3 VAT PP for loaded material/2 L-PBF-LB (SLS)/2 DLP 3 MEX (FDM) covering a wide range of temperatures/ an extrusion head mounted on a Cobot
- AM Feedstock material characterization: Powder lab/ thermal analysis chain adapted to the field of AM
- AM Part quality: Internal stress (DRX) and deformation (Atos 5 Scanner)/mechanical testing

#### International collaborations:

Focus = Belgium as Belgian technology center

## Manufacturing of dense and porous Materials

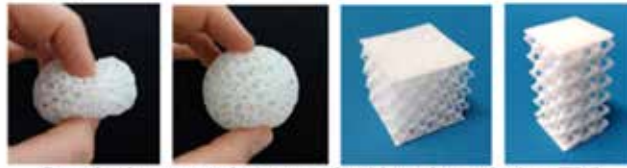

Exemples de structures lattices en polyuréthane thermoplastique (TPU).

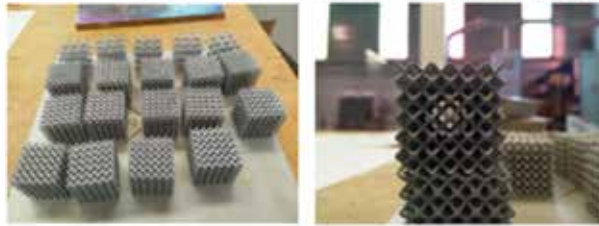

### Pure Copper for Electrical application



### Printed Electronics



## Main relevant publications

- Magnien J, Cosemans P, Nutal N, Kairet T. Current surface issues in additive manufacturing. Plasma Process Polym. 2020;17:e1900154
- YADAV, Pinku, RIGO, Olivier, ARVIEU, Corinne, et al. In situ monitoring systems of the SLM process: On the need to develop machine learning models for data processing. Crystals, 2020, vol. 10, no 6, p. 524
- Pauline Delroisse, Matthieu Marteleur, Olivier Rigo, Catherine Doneux, Gregory Pyka, Martine Wevers, Pascal J. Jacques, Aude Simar: "Comparison of the impact resistance of honeycombs and LBM lattice structures" - Workshop on additive manufacturing for space application- ESTEC Noordwijk, Netherlands, 2014.
- Denis Vandormael, Olivier Rigo, Laurent Seronveaux: "Direct deposition of surface acoustic wave by aerosol jet printing technique" - Smart system Intergration - VDE verlag publishing, Berlin, 2012

Participating in FL/B/EU funded projects with H<sub>2</sub> related research: -

Contact persons:

[guido.heunen@sirris.be](mailto:guido.heunen@sirris.be) & [Olivier.rigo@sirris.be](mailto:Olivier.rigo@sirris.be):

## VKI: Research Expertise Group on Liquid & Solid Propulsion

### von Karman Institute for Fluid Dynamics / Aerospace Department

General expertise of the research group

#### DENSIFIED CRYOGENIC STORAGE

Experimental testing and numerical simulation of the fluid dynamic behaviour for 2-phase flows and multi-phase flows, with application for liquid hydrogen and other cryogenic (e-)fuels. Extensive expertise is available from research on the propellant management system for space launchers. This expertise which have been developed for space applications, is now being transferred to terrestrial applications, both for terrestrial mobility (in ships, aircraft, heavy duty trucks...) and for energy applications (long term H<sub>2</sub> storage and long distance H<sub>2</sub> transport).

Specific hydrogen- related expertise & research topics

- In general: numerical simulations of liquid hydrogen behaviour and performing experimental tests to validate the modelling
- Densified Cryogenic eFuels (“Slush”): hydrogen, methane, LNG (also applicable to CO<sub>2</sub>)

Available equipment/tools:

- Numerical simulation platforms for CFD (Computational Fluid Dynamics), e.g. EcosimPro, OpenFOAM®
- Experimental test facilities:
  - PREDICT and BECASSINE Facility: for testing for densified cryogenic (e-)fuels.
  - Particle Image Velocimetry

Participating in FL/B/EU funded projects with H<sub>2</sub> related research:

- **[SPACE] PREDICT DREAMS** is the continuation of PREDICT (experimental characterization of a [slurry flow or densified cryogenic flow](#) in hydraulic similitude with future cryogenic propellant at the triple point) in the framework of a PhD thesis. In this activity, both numerical simulation and experimental investigations are carried out. A CFD solver based on a Euler-Euler approach coupled with the Granular Kinetic Energy theory is in development, satisfactory results were obtained once validated against the PREDICT experimental data. The final ambitious goal targets experiments characterizing a slush flow and possibly evaluate the solver performances. Funding: FRIA/FNRS and ESA – NPI.
- **[ENERGY] Be-HyFE (Belgian Hydrogen Fundamental Expertise)**: this project aims at developing a Belgian PhD network with PhD level research on hydrogen, about many different topics across the hydrogen value chain. The VKI PhD will focus on advanced characterization of thermodynamic properties of densified cryogenic hydrogen (or e-fuels more in general): composition (crystals shape and size), aging dynamics (stratification, melting), rheology and behaviour in pipelines and their components. This densified cryogenic slush is a promising solution to increase the volumetric density for storage and increase the resistance against boil-offs and heat losses during long distance transportation. Funding: Energy Transition Fund, by the Belgian Federal Public Services “Economy”.

#### International and industrial collaborations:

- Ariane Group (FR, DE)
- CiRA (UK)
- DLR (DE)
- Numeca (BE)
- Open Engineering (BE)
- Waseda University Tokyo (JPN)

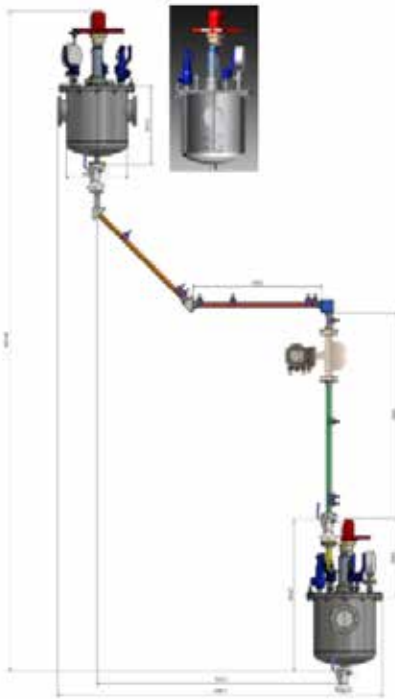

*PREDICT Facility, for experimental characterization of densified cryogenic fuels*

#### Main relevant publications

- Two-Phase Flows Investigations in Liquid Propulsion Systems: “TRL Booster” research at the von Karman Institute, by Jean-Baptiste Gouriet, Cryogenic Heat & Mass Transfer symposium, TU Twente (Enschede), november 2019

#### Contact persons:

- Jean-Baptiste Gouriet – Research Manager
- Peter Simkens – Business Development Manager



## *KU Leuven; Department of Electrical Engineering/ Electrical Energy Applications Ghent*

### KU Leuven, Faculty of Engineering

The research group carries out applied research related to electrical energy. This comprises: Power electronic applications, storage of electricity, integration of PV, protection of distribution grids under the impact of power electronics and electrical bikes.

#### Specific hydrogen- related expertise & research topics

- Practical evaluation as hydrogen as a storage for electrical distribution grids

#### Available equipment/tools:

- Power analyzers (Yokogawa)
- Power-Quality meters (Fluke)
- Test bench for electrical bikes
- Programmable multi-phase AC current and voltage source (Omicron)
- Programmable DC source and load

#### Participating in FL/B/EU funded projects with H<sub>2</sub> related research:

- H<sub>2</sub> for all, TETRA

#### International collaborations: -

#### Main relevant publications: -

#### Contact persons:

Prof. Michael Kleemann  
[michael.kleemann@kuleuven.be](mailto:michael.kleemann@kuleuven.be)  
 Tel. + 32 9 267 2703

## *UGent: Dept. Electromechanical, Systems and Metal Engineering – EELAB & Lemcko*

Ghent University, Faculty of Engineering and Architecture

General expertise of the research group:

Low frequency electromagnetic fields and magnetic materials

Power Systems

Power Electronics

Drive systems and control for electrical machines

Energy and cluster management

Specific hydrogen- related expertise & research topics:

- Electrolyser electrical grid integration aspects, flexibility
- power-to-X
- power generation grid support (X-to-power)

Available equipment/tools:

International collaborations:

Participating in FL/B/EU funded projects with H<sub>2</sub> related research:

- BEST (Energy Transition Fund, PhD with UCLouvain)
- InduFlexControl (Catalisti cSBO)
- CO2PERATE (Catalisti SBO)
- GREENPORTS (Flux50 ICON)
- See website: [research.ugent.be](https://research.ugent.be)

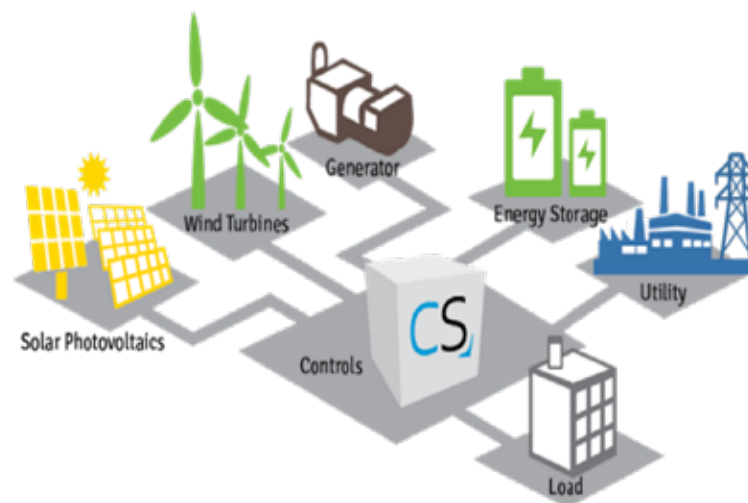

#### Main relevant publications:

- See website: [biblio.ugent.be](http://biblio.ugent.be)
- Dadkhah A, Bozalakov D, De Kooning J, Vandeveld L. On the optimal planning of a hydrogen refuelling station participating in the electricity and balancing markets. *INTERNATIONAL JOURNAL OF HYDROGEN ENERGY*. 2021;46(2):1488–500.
- Ebneali Samani A, D’Amicis A, De Kooning J, Bozalakov D, Silva P, Vandeveld L. Grid balancing with a large-scale electrolyser providing primary reserve. *IET RENEWABLE POWER GENERATION*. 2020;14(16):3070–8.
- Baetens J, De Kooning J, Van Eetvelde G, Vandeveld L. A two-stage stochastic optimisation methodology for the operation of a chlor-alkali electrolyser under variable DAM and FCR market prices. *ENERGIES*. 2020;13(21).

#### Contact persons:

Louis Sileghem ([louis.sileghem@ugent.be](mailto:louis.sileghem@ugent.be))

Hydrogen Platform Manager UGent

T +32 496 63 16 01

Prof. Lieven Vandeveld ([lieven.vandeveld@ugent.be](mailto:lieven.vandeveld@ugent.be))

Prof. Greet Van Eetvelde ([greet.vaneetvelde@ugent.be](mailto:greet.vaneetvelde@ugent.be))

Prof. Jan Desmet ([janj.desmet@ugent.be](mailto:janj.desmet@ugent.be))

Department of Electromechanical, Systems and Metal Engineering (EMSME)

Tech Lane Ghent Science Park - Campus Ardoyen

Technologiepark-Zwijnaarde 131

B-9052 Gent

T: +32 9 264 34 18

F: +32 9 264 35 82

# 4 Use of hydrogen

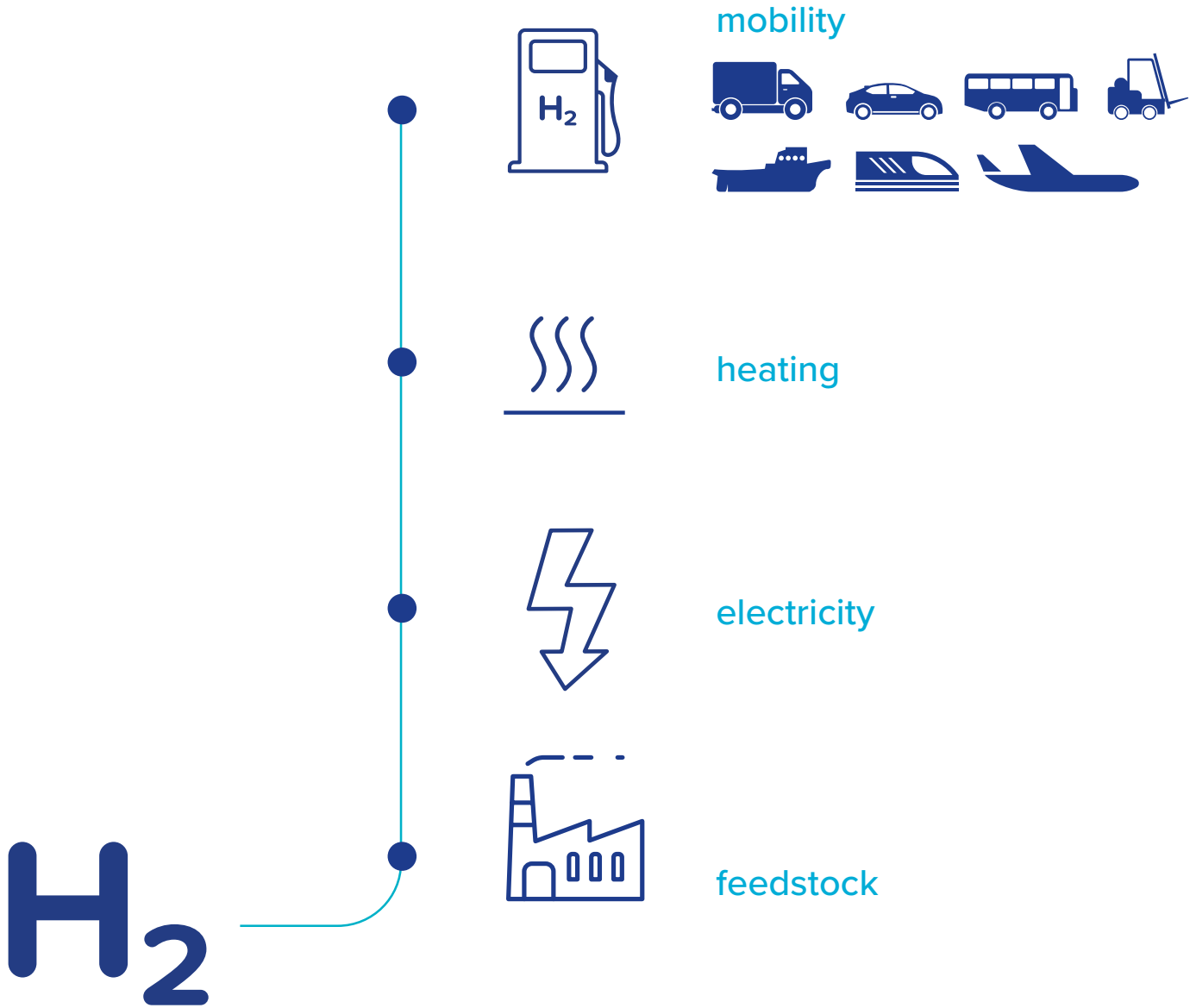

## VUB: FLOW: Thermo and Fluid Dynamics

### VUB, Engineering

#### General expertise of the research group

At FLOW, we focus on ensuring access to sustainable energy for all, which is one of the sustainable development goals of the United Nations. We tackle this challenging mission through 3 research topics: circular energy, low emissions, and flexible energy systems. We have expertise in thermodynamics, fluid mechanics, combustion, CFD simulations, system modelling and data driven modelling.

In the field of Hydrogen, our current focus is on the combustion of hydrogen and related e-fuels for power production and other industrial applications. In near future also focus on safety issues related to hydrogen storage and use.

#### Specific hydrogen- related expertise & research topics

- Combustion of H<sub>2</sub> and H<sub>2</sub>-based carriers
- CFD simulations
- Kinetic mechanisms
- Thermodynamic process modelling and integration
- Power plants
- Flue gas treatment
- Storage

#### Participating in FL/B/EU funded projects with H<sub>2</sub> related research:

BEST: Belgian Energy System.

Role of e-fuels in the Belgian energy system, 2020-2024, ETF: Energy Transition Funds.

Partners: UCL, ULB, UMons, UGent, VUB.

#### Available equipment/tools:

- Micro-gas turbine Turbec T100 (100 kWe)

#### International collaborations:

Main relevant publications: -

#### Contact persons:

Julien Blondeau, [Julien.blondeau@vub.be](mailto:Julien.blondeau@vub.be), 0473/695.895.

## Research Expertise Group on Liquid & Solid Propulsion

von Karman Institute for Fluid Dynamics / Aerospace Department

General expertise of the research group

### DESIGN AND OPTIMISATION OF CRITICAL COMPONENTS FOR A LH2 PROPULSION SYSTEM, SUCH AS LH2 FUEL TANKS, VALVES, HEAT EXCHANGERS...

Experimental testing and numerical simulation of the fluid dynamics behaviour for two-phase flows, with application for liquid hydrogen (LH<sub>2</sub>). Extensive expertise is available from research on the propellant management system for space launchers. This expertise which has been developed for space applications, is now being transferred to terrestrial mobility applications in ships, aircraft, heavy duty trucks...

Specific hydrogen- related expertise & research topics

- In general: numerical simulations of fluid dynamics behaviour of liquid hydrogen (LH<sub>2</sub>) and performing experimental tests to validate the modelling
- Fluid Dynamics Phenomena of Liquid Hydrogen in a propellant management system (in pumps, piping, valves...):
  - cavitation
  - boil-offs and heat transfer
  - fluid hammering
- Sloshing of cryogenic fuels in a fuel tank (on board of a ship, a plane, a truck or in a space launcher...)

Available equipment/tools:

- Numerical simulation platforms for CFD (Computational Fluid Dynamics), e.g. EcosimPro, OpenFOAM®
- Experimental test facilities:
  - Cryoline Facility: a large multipurpose facility, which allows the characterization of cryogenic valves and the study of cryogenic water hammer and chill-down phenomena. The CryoLine facility can be placed horizontally, vertically and at intermediate angles to study the effect of gravity direction on cryogenic two-phase flows. Characterization of The facility allows measurement of temperature, pressure, flow rate and visualization of the flow (single phase or two-phase) during transient and at steady state.
  - The "CryME" (Cryogenic Microgravity Experiments) facility is a fully customized cryostat, for the characterization of cryogenic sloshing, boiling and thermal stratification on earth and in microgravity conditions at temperature down to 70 K. The presence of large windows allows the use of non-intrusive optical techniques such as particle image velocimetry or high-speed visualization.
  - CHIEF Facility and upgraded CHIEF Facility: for testing cryo-valves
  - PREDICT and BECASSINE Facility: for testing for densified cryogenic (e-)fuels.
  - Sloshing table
  - Particle Image Velocimetry

### Participating in FL/B/EU funded projects with H<sub>2</sub> related research:

- **[SPACE] CRYOSLOSH** and its continuation **SLOSH II** deal with the problem of **sloshing in cryogenic propellants**, stored in a reservoir. The main scope is to improve the state-of-the-art knowledge of the numerical simulation of liquid hydrogen, by refining actual models and performing coordinated experiments for their validation. SLOSH II focuses on introducing non-isothermal conditions on the hydrodynamic problem and provides model(s) for the contact-angle boundary condition. Funding: ESA – GSTP; partners: Numeca).
- **[SPACE] The SPARGE I & II** projects concern the isothermal characterization of **sloshing** in microgravity conditions, when surface tension forces are dominant. Parabolic flights represent a good tool to achieve microgravity conditions which are compatible with the ones obtained in real conditions (satellite or space vehicle propeller tanks). Funding: ESA – Continuously Open Research Announcement.
- **[SPACE] CRYOBUBBLE** is related to the experimental study and modelling of the **transient chill down phenomena** occurring when a cryogenic liquid is introduced into a system at ambient conditions. Such situation is happening at the initial start of a cryogenic system prior to operation. Heat exchanges between the cryogenic fluid and the system lead to vaporization and boiling phenomena as well as a cool down of the whole system. In this project, the cool-down created by a LN<sub>2</sub> flow into a pipe at ambient temperature is studied both experimentally and numerically.
- **[SPACE] CRYOVANNE II** focuses on the multiphysics study of the behavior of a **cavitating** valve in cryogenic conditions. The development of new valves for space applications is going more and more towards electromechanically operated valves to reduce the mass demands. It requires improving the prediction of the expected thermo-mechanical loads on the valves, in particular during its transient operations. Due to the complexity of the multi-phase phenomena and the lack of literature describing benchmark experiments, the physical models implemented in the numerical codes cannot be validated properly. Therefore, the scope of this project was to investigate the physics involved during transient phenomena, such as flashing and water hammer, due to the fast closure or opening of valves designed for cryogenic fluids. Funding: ESA – GSPT. Partners: Safran Aero Boosters, Open Engineering, ET Energy Technology.
- **[MARITIME / SHIPPING] CHyPS (Clean Hydrogen Propulsion for Ships)** focuses on development of high fidelity 3D simulation models, needed for the engineering of clean propulsion for ships, with fuels such as H<sub>2</sub>, e-methane or methanol. The projects aims at developing models for the storage of cryogenic fuels in a tank, looking at phenomena such as **sloshing and boil-off**, and models for the combustion of these fuels in an Internal Combustion Engine (ICE) for ships. Flemish regional funding via VLAIO and the Blue Cluster.
- **[AVIATION] HYPSTER (HYdrogen Propulsion System: Thermique Et Régulation)**: aims at designing, manufacturing and demonstrating 2 key components in the fuel delivery system for future hydrogen powered aircraft, namely the cryogenic valves and the heat exchanger. The project team, lead by Safran Aero Booster, will provide these components to Airbus, for integration in the ZEROe A380 flying testbed. In this project team, VKI is in charge of the design of the **heat exchanger** and of the testing in subcritical and supercritical regimes. The heat exchanger is used to bring the cryogenic LH<sub>2</sub> to the right gaseous conditions. VKI also does the 1D modeling of the fuel delivery system. Walloon regional funding via the Skywin cluster.

- **[AVIATION] fLHYing tank:** this project, lead by Pipistrel Vertical Solutions from Slovenia, aims at developing a liquid hydrogen (LH2) load bearing fuel tank, which can fit in the tail cone of smaller aircraft. It will be demonstrated in flight with a Pipistrel NUUVA large cargo UAV. VKI will develop the **digital twin for the thermo-fluid dynamics** of the LH2 tank, will design the instrumentation for the performance characterisation and will perform the experimental validation. Funding by the European Clean Aviation R&D programme.

International and industrial collaborations:

- Airbus
- Ariane Group (FR, DE)
- CiRA (UK)
- DLR (DE)
- Numeca (BE)
- Open Engineering (BE)
- Pipistrel Vertical Solutions (SLO)
- Polytecnico di Torino (IT)
- Safran Aero Boosters (BE, FR)
- Waseda University Tokyo (JPN)



*Experimental testing of sloshing of liquid hydrogen in a fuel tank, in the “Cryostat” test facility, with visualisation with Particle Image Velocimetry (PIV)*





*Flying testbeds on which components for hydrogen powered aviation, designed by VKI, will be demonstrated: the Airbus ZEROe A380 flying testbed and the Pipistrel NUUVA large cargo UAV.*

#### Main relevant publications

Two-Phase Flows Investigations in Liquid Propulsion Systems: “TRL Booster” research at the von Karman Institute, by Jean-Baptiste Gouriet, Cryogenic Heat & Mass Transfer symposium, TU Twente (Enschede), november 2019

#### Contact persons:

Jean-Baptiste Gouriet – Research Manager of the Aerospace Department

Peter Simkens – Business Development Manager

## VKI: Research Expertise Group on High Speed Propulsion & Combustion

von Karman Institute for Fluid Dynamics / Turbomachinery & Propulsion Department

### General expertise of the research group

Utilisation of (liquid) hydrogen as propellant in airplanes or spacecraft, in combustion engines or thrusters:

- Combustion of hydrogen in turbines, for jet engines and for energy production
- (Pulsed) Detonation of hydrogen for aerospace propulsion

### Specific hydrogen- related expertise & research topics

- Combustion models for thermodynamic modelling of hydrogen powered engines for hypersonic flight
- Numerical modelling, experimental validation
- Emission calculation
- Jet-noise modelling and testing

### Available equipment/tools:

- Facilities:
  - JAJAAR (Jet Aeroacoustic Facility for Aeronautical & Aerospace Research): the aeronautical applications concern mainly airframe noise with a focus on high-lift devices. The aerospace applications include launcher rocket noise, and supersonic boundary layer studies. The facility permits jet noise studies up to Mach 2, in single or a coaxial jet configurations with an outlet diameter of the order of 0.05 m. The flow is quietened by means of a silencer, and the jet discharges in an anechoic room with dimensions (4 x 3 x 4) m<sup>3</sup> and with a cut-off frequency of 200 Hz. The facility can also accommodate a free-jet test section with side-plates for airframe noise research.
  - H3 (Mach 6 Hypersonic Wind Tunnel): the hypersonic tunnel H3 is a blow-down facility with an axisymmetric nozzle giving a uniform Mach 6 free jet 12 cm in diameter. Air is supplied at 7-35 bar stagnation pressure and a maximum 550 K stagnation temperature. Reynolds number may be varied from 3 x 10<sup>6</sup> to 30 x 10<sup>6</sup>/m.
- Software & CFD platforms:
  - Ecosimpro
  - Fluent
  - Chemkin
  - WRF
  - OpenFOAM®

#### International & Industrial Collaborations:

- BOEING (USA)
- BOOM (USA)
- CiRA (UK)
- CNRS (FR)
- DLR (DE)
- Politecnico di Torino (IT)
- LUND University (SE)
- QinetiQ (BE / UK)
- TU Delft (NL)

#### Participating in FL/B/EU funded projects with H<sub>2</sub> related research:

- STRATOFly investigates the feasibility analysis of high-speed passenger stratospheric flight with respect to key technological, societal and economical aspects. The goal of STRATOFly is to refine the design of a hypersonic vehicle able to fly at about 10,000 Km/h (Mach 8) above 30 km of altitude. The project will focus on the integration of innovative propulsion systems, unconventional structural configurations and systems for the thermal and energy management of the vehicle. Taking into account sustainability, the project will investigate strategies to reduce gas and noise emissions, while at the same time ensuring the required safety levels for passengers. The project aims at drastically increasing the efficiency of the thermodynamic cycle (>15%) by exploiting fuels cryogenically stored in the tanks. This efficiency gain will be quantified in terms of reduction of fuel consumption, emissions (75% to 100% reduction in CO<sub>2</sub> emissions per passenger kilometer, 90% reduction in NO<sub>x</sub> emissions) and noise. Funding: EC – H2020. Partners: Politecnico di Torino, TUHH, UDC, CiRA, DLR
- MORE & LESS aims at MORE sustainable fuels, environmental protection and citizens protection, and LESS pollutant emissions, noise emissions and impact on air quality, ozone layer and climate: it aims at low-boom and environmentally sustainable supersonic aviation. The objective is to thermodynamically design and optimize 3 propulsion system components (inlet, turbomachinery and nozzle) for Mach 2 aircraft and for a Stratofly concept for Mach 5. MORE & LESS runs URANS simulations of hydrogen and bio-fuel combustion, for propulsion and pollutant emission determination. MORE & LESS performs aerodynamic testing, aeroacoustic jet noise modeling and experimental testing, and sonic boom propagation. Funding: Cleansky 2. Partners: Polito, BOOM, CIRA, CNRS, DLR, ECATS, FICG, INCAS, ISL, LUND University, BOEING, TU Delft, TUHH
- PDT aims at numerically and experimentally proving/disproving pulse-detonation thruster as a viable option for spacecraft propulsion. After doing a thorough requirement review, 1D simulations on a number of viable solutions, and 3D CFD simulations, 2 PDT candidates are selected. With a trade-off analysis, the final PDT design is consolidated for testing. H<sub>2</sub>-O<sub>2</sub> detonation experiments are performed under vacuum conditions, providing a vast amount of data to validate the numerical tools. Funding: ESA; partners: COMOTI, UPM, QinetiQ



#### Main relevant publications

- Saracoglu B.H., Cutrone L., Marini M., Assessment of combustion models for thermodynamic modeling of the engines for hypersonic propulsion, International Conference on Flight vehicles, Aerothermodynamics and Re-entry Missions and Engineering (FAR) 30 September - 3 October 2019
- Ispir A.C., Gonçalves P.M., Saracoglu B.H., Analysis of a combined cycle propulsion system for STRATOFly hypersonic vehicle over an extended trajectory, MATEC Web of Conferences 304
- Goncalves P.M., Ispir A.C., Saracoglu B.H., Development and optimization of a hypersonic civil aircraft propulsion plant with regenerator system, AIAA Propulsion and Energy 2019 Forum
- Ali C. Ispir, Pedro M. Goncalves & Bayindir H Saracoglu, Thermodynamic efficiency analysis and investigation of exergetic effectiveness of STRATOFly aircraft propulsion plant, by., AIAA 2020-1108, January 2020

#### Contact persons:

- Bayindir Saracoglu – Research Manager
- Peter Simkens – Business Development Manager

## UGent: Transport Technology

### Ghent University, Faculty of Engineering and Architecture

#### General expertise of the research group:

The research group Transport Technology at Ghent University is specialized in internal combustion engines operating on renewable fuels. The group's research is going from the heart of the engine: the in-cylinder processes (spray formation, combustion, heat transfer and emission formation), to the engine as part of a sustainable energy system (power-to-x, vehicle propulsion, ...). The group's vision is to enable the transition to sustainable transportation through finding the best engine and fuel for each application. Its mission is therefore to provide appropriate R&D tools to the research community and industry, training to students and researchers, and guidelines to policy makers.

#### Specific hydrogen- related expertise & research topics:

- Internal combustion engines (ICEs) on e-fuels, with the main expertise being on hydrogen and methanol
- Power, efficiency, emissions
- Simulations of ICE on e-fuels

#### Available equipment/tools:

- 5 engine test benches, with dynamometer capability to 300 kW
- Combustion vessel with high speed camera
- Gaseous emissions measurement (CO, CO<sub>2</sub>, NO<sub>x</sub>, O<sub>2</sub>)

#### International collaborations:

#### Participating in FL/B/EU funded projects with H<sub>2</sub> related research:

- FASTWATER (EU, 2020-2024, 1 PhD)
- BEST (National, 2020-2024, 1 PhD)
- PhD Baekeland (Flemish, 2020-2024, 1 PhD)
- CHyPS (Intercluster cSBO, 2022-2024, 1 PhD)
- MMU (VIL COOCK, 2021-2024, 1 PhD)
- See website: [research.ugent.be](https://research.ugent.be)



#### Main relevant publications:

- See website: [biblio.ugent.be](http://biblio.ugent.be)
- Verhelst S., Sierens R., A quasi-dimensional model for the power cycle of a hydrogen fuelled ICE. *International Journal of Hydrogen Energy*, Vol. 32, pp. 3545-3554, October 2007
- Verhelst S., Wallner T., Hydrogen-Fueled Internal Combustion Engines. *Progress in Energy and Combustion Science*, Vol. 35, pp. 490-527, December 2009
- Verhelst S., Wallner T., Eichseder H., Naganuma K., Gerbig F., Boyer B., Tanno S., Electricity Powering Combustion: Hydrogen Engines, *Proceedings of the IEEE* Vol. 100, pp. 427-439, February 2012
- Vancoillie J., Demuynck J., Sileghem L., Van De Ginste M., Verhelst S., Comparison of the renewable transportation fuels, hydrogen and methanol formed from hydrogen, with gasoline - Engine efficiency study, *International Journal of Hydrogen Energy* Vol. 37, pp. 9914-9924
- Verhelst S., Recent progress in the use of hydrogen as a fuel for internal combustion engines, *International Journal of Hydrogen Energy*, invited paper, Vol. 39, pp. 1071-1085, January 2014
- Verhelst S., Demuynck J., Sierens R., Scarcelli R., Matthias N., Wallner T., Hydrogen-fueled internal combustion engines, in 'Renewable Hydrogen Technologies. Production, Purification, Storage, Applications and Safety', Chapter 16, pp381-400, edited by L.M. Gandía, G. Arzamendi, P.M. Diéguez, Elsevier, ISBN 978-0444563521
- Verhelst S., Wallner T., Hydrogen-fueled internal combustion engines, in 'Handbook of Hydrogen Energy', pp. 821-901, edited by S.A. Sherif, Y. Goswami, E. Stefanakos, A. Steinfeld; CRC/Taylor and Francis, ISBN 978-1420054477.

#### Contact persons:

Louis Sileghem ([Louis.Sileghem@UGent.be](mailto:Louis.Sileghem@UGent.be))  
Hydrogen Platform Manager UGent  
T +32 496 63 16 01

Prof. Sebastian Verhelst ([Sebastian.Verhelst@UGent.be](mailto:Sebastian.Verhelst@UGent.be))  
Sint-Pietersnieuwstraat 41  
Technicum building 4  
B-9000 Gent  
T: +32 9 264 33 59  
T: +32 9 264 32 88

## Thomas More: De Nayer/ Automotive

### Thomas More university of applied sciences

#### General expertise of the research group

Hydrogen Internal Combustion Engines Applied Research

Hydrogen Internal Combustion Engine Applications in Vehicles

Storage of hydrogen in mobile applications

#### Specific hydrogen- related expertise & research topics

- Practical applications of hydrogen in combustion engines.
- Evaluation of components and systems for hydrogen gasoline applications in hydrogen internal combustion engines.
- Measurement of parameters of hydrogen internal combustion engines.
- Combustion simulations on hydrogen internal combustion engines.
- Integration of hydrogen components in mobile hydrogen applications
- Hydrogen combustion engines as a basis in energy storage systems

#### Participating in FL/B/EU funded projects with H<sub>2</sub> related research: -



### Main relevant publications

- Don't change the engine change the fuel Europe Spotlight Newsletter January 2016: [http://sae-europe.org/articles/don-t-change-the-engine-change-the-fuel.html?mkt\\_tok=3RkMMJWWf-F9wsRoluanOZKXonjHpfsX74uolXqSg38431UFwdcjKpmjr1YEDTcN0aPyQAgobGp5I5FENSLXYTqNnt-6QPUg%3D%3D](http://sae-europe.org/articles/don-t-change-the-engine-change-the-fuel.html?mkt_tok=3RkMMJWWf-F9wsRoluanOZKXonjHpfsX74uolXqSg38431UFwdcjKpmjr1YEDTcN0aPyQAgobGp5I5FENSLXYTqNnt-6QPUg%3D%3D)
- Road Book of innovation "28 inspiring conversations": ISBN 9789460581144 2012 Luster Antwerp
- Institution of mechanical engineers 2012-11 "Evolutionary decarbonisation of transport: A contiguous roadmap to affordable mobility using sustainable organic fuels for transport" J W G Turner, R J Pearson, Lotus Engineering, UK; P Harrison, A Marmont, R Jennings, Air Fuel Synthesis Limited, UK; S Verhelst, J Vancoilli, L Sileghem, Ghent University, Belgium; M Pecqueur, K Martens, Karel de Grote University Of applied science, Belgium; P P Edwards, University of Oxford, UK
- SAE 2011-01-9166 The technical implementation of a retrofit hydrogen PFI system on a passenger car. P. Huyskens, S. Van Oost, P.J. Goemaere, K. Bertels, M. Pecqueur
- SAE 2008-08CV-0023 Emissions generated from a Suzuki Liane running on unleaded gasoline and LPG under the same load conditions; M. Pecqueur, K. Ceustermans, P. Huyskens, D. Savvidis

### Available equipment/tools:

- Hydrogen combustion engine test stands
- Chassis dyno for vehicles on hydrogen combustion engines
- In cylinder pressure measuring systems for internal combustion engines
- Simulation software for hydrogen combustion engines

### International collaborations:

- California Hydrogen Business Council – CHBC
- SAE International



## VIVES :Centre of expertise smart technologies – research group hydrogen

### VIVES University of applied sciences, research group hydrogen

#### General expertise of the research group

The research group hydrogen can rely on a fully equipped laboratory of the hydrogen energy chain. From production, up to the use of hydrogen in different applications. The group has gained expertise in practical use and implementation of green hydrogen production, hydrogen storage, hydrogen permitting, , hydrogen as a fuel for internal combustion engines, hydrogen fuel cell systems, fuel cell vehicles, and green methanol.

#### Specific hydrogen- related expertise & research topics

- expertise in hydrogen combustion, dual fuel engine, genset 250 kVA (diesel and hydrogen), low level control management and data acquisition and visualisation
- expertise in hydrogen PEM Fuel cell systems (10 kW size), system design, control, and data acquisition
- expertise in fuel cell vehicle technology, reverse engineering, system lay out and working principles
- expertise in production of green hydrogen with solar and wind energy and PEM elektrolyser
- Research
  - Fuel cell system modelling, control and implementation
  - Hydrogen for combustion engines
  - CCU
  - Green methanol

#### Available equipment/tools:

- Solar panels
- PEM elektrolyser 10 kW with water treatment
- Compressor 300 bar
- Slow filling station for FCEV
- Hydrogen storage
- Hydrogen supply infrastructure
- Fuel cell system 8 kW
- Fuel cell system 6.8 kW
- Genset Atlas Copco dual fuel 250 kVA
- Genset Caterpillar Direct injection 33kVA
- Resistive load bench 20 kW & 300 kW
- Toyota Mirai
- 4W vehicle Test bench
- 2W vehicle Test bench
- Engine test bench water brake

Participating in FL/B/EU funded projects with H<sub>2</sub> related research:

- Interreg 2 Seas - ISHY project implementation of ship hybridisation
  - Retrofit of an existing diesel genset 250 kVA to dual fuel mode (hydrogen and pilot diesel)
  - Port of Ostend, Parkwind, GeoXyz, TU Delft, Solent University, Hybrid marine
- H<sub>2</sub> ElektrolyzE
  - PEM elektrolyser demonstrator for production of green hydrogen
  - Cinergy, AA Technics, e-BO enterprises, Bekaert, Van Marcke Technics
- IOF C3: Direct injection of hydrogen for ICE
  - Building a demonstrator for testing of direct injection of hydrogen and strategies
  - In cooperation with KU Leuven
- BELSPO DEFRA – Hyde : Sustainable and “green” energy applications for military use
  - Modelling and building of a demonstrator
  - In cooperation with KU Leuven, Solenco and Royal Military Academy
- Interreg north sea region – REDII ports: Renewable energy development an intelligent implementation in PORTS
  - Resource study and building of a CCU demonstrator for green methanol production and use in an internal combustion engine
  - Port of Skagen, Ports Niedersachsen, Korsor Havn, NICE, BDI, Port of Brest, Port of Brussels

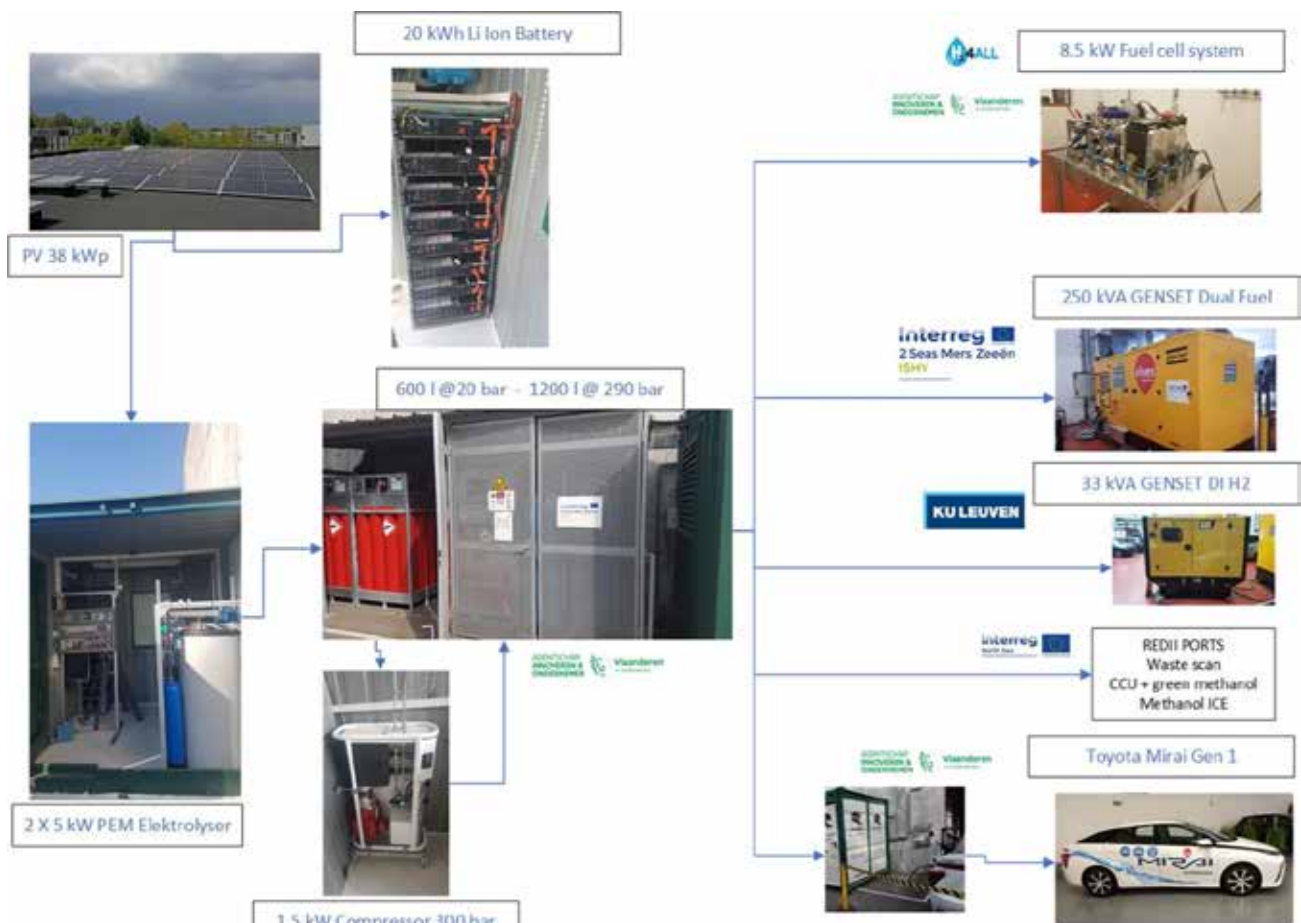

### Main relevant publications

- J. Mus et al., "Design and Characterisation of an Alkaline Electrolyser," 2022 11th International Conference on Renewable Energy Research and Application (ICRERA), 2022, pp. 253-259, doi: 10.1109/ICRERA55966.2022.9922902.
- De Wilde, B., Schotte, S. (contr.) (2022). Hogeschool VIVES opent nieuw waterstofcentrum VRT NWS. (URL)
- Buyschaert, F., Mus, J., De Tollenaere, S., Schotte, S., Van Luchem, P. (contr.) (2021). Webinar: Hoe starten met toepassingen op waterstofgas?
- Mus, J., Mylle, S., Schotte, S., Fevery, S., Latré, S., Buyschaert, F. (2022). CFD Modelling and Simulation of PEMFCs in STAR-CCM+. In: 2022 11th International Conference on Renewable Energy Research and Application (ICRERA), (260-267). Presented at the International Conference on Renewable Energy Research and Application (ICRERA), Istanbul, Turkey,

### International collaborations:

- TU Delft
- Solent University Southampton
- UHPF
- NICE
- BDI

### Contact persons:

Sam Schotte: [sam.schotte@vives.be](mailto:sam.schotte@vives.be)

Steven De Tollenaere: [steven.detollenaere@vives.be](mailto:steven.detollenaere@vives.be)

## Dept. Mechanical Engineering/ TME (M-Group)

KU Leuven, Bruges Campus, Faculty of Engineering Technology

### General expertise of the research group

The M-Group research team has a unique composition, including three departments - Mechanical Engineering, Electrical Engineering, and Computer Science. The primary focus of the M-Group is to investigate the reliability and dependability of highly automated interconnected mechatronic systems, where the **TME@M-Group has a particular emphasis on unmanned aerial systems and hybrid hydrogen-based propulsion systems**. The team consists of experts in various areas, including sensor networks and algorithms (Prof. H. Hallez), software dependability (Prof. J. Boydens), hardware and system safety (Prof. D. Pissoort), Artificial Intelligence and machine learning (Prof. M. Verbeke), H<sub>2</sub> based systems for drone applications (Prof. F. Buyschaert), and dependable lightweight structures for aeronautics (Prof. G. Serhat).

### Specific hydrogen- related expertise & research topics

- Dependable hybrid drone propulsion with fuel cells.

### Participating in FL/B/EU funded projects with H<sub>2</sub> related research:

- HYDE. Hydrogen technology for Defence applications, DEFRA Belspo. Partners: KU Leuven, VIVES Zuid, VIVES Noord, Solenco Power.
- H<sub>2</sub>-4-All. Fuel cell technologies for industry, VLAIO TETRA. Partners: VIVES-Zuid, KU Leuven, VIVES-Noord

### Available equipment/tools:

- Electronic loads
- FRA
- Fuel cells
- Modified Climate chambers, including mechanical stress (tension, pressure and shearing) and UV radiation
- Halt (Highly Accelerated lifetime testing)
- EMC test equipment (via FMEC, M-Group)

### Main relevant publications

Mus, J., Vanhoutte, B., Schotte, S., Fevery, S., Latré, S., Kleemann, M., Buyschaert, F. (2022). Design and Characterisation of an Alkaline Electrolyser. In: 2022 11th International Conference on Renewable Energy Research and Application (ICRERA), (253-259). Presented at the International Conference on Renewable Energy Research and Application (ICRERA), Istanbul, Turkey, 18 Sep 2022-21 Sep 2022. ISBN: 978-1-6654-7140-4. doi: 10.1109/ICRERA55966.2022.9922902

Mus, J., Mylle, S., Schotte, S., Fevery, S., Latré, S., Buyschaert, F. (2022). CFD Modelling and Simulation of PEMFCs in STAR-CCM+. In: 2022 11th International Conference on Renewable Energy Research and Application (ICRERA), (260-267). Presented at the International Conference on Renewable Energy Research and Application (ICRERA), Istanbul, Turkey, 18 Sep 2022-21 Oct 2022. ISBN: 978-1-6654-7140-4. doi: 10.1109/ICRERA55966.2022.9922908

Buyschaert, F., Mus, J. (2022). Waterstof en drones. Presented at the Drone West 22, Ostend, Belgium. (professionally oriented)

Buyschaert, F., Van Luchem, P. (2022). Hydrogen Tech Day - Workshop: Regulations. Presented at the Hydrogen Tech Day, Kortrijk, Belgium. (professionally oriented)

Mus, J., Buyschaert, F. (2022). Modelling & Characterization of Electrochemical Energy Systems. Presented at the Chemical Research in Flanders - Chemistry Conference for Young Scientists (CRF-ChemCYS), Blankenberge, Belgium.

Schotte, S., De Tollenaere, S., Buyschaert, F., Mus, J., Uytterhaegen, B., van luchem, P. (2020). H<sub>2</sub>-4-All presentation Fuel cell system. Presentation H<sub>2</sub>-4-All basics Fuel cells system.

Buyschaert, F., Mus, J., De Tollenaere, S., Schotte, S., Van Luchem, P. (2021). Webinar: Hoe starten met toepassingen op waterstofgas?

### Contact persons:

Frank Buyschaert ([frank.buyschaert@kuleuven.be](mailto:frank.buyschaert@kuleuven.be))

Dries Vanoost ([dries.vanoost@kuleuven.be](mailto:dries.vanoost@kuleuven.be))

## *KU Leuven: Mechanical Engineering Department/Applied Mechanics and Energy Conversion (TME) Division*

### KU Leuven, Faculty of Engineering Technology

#### General expertise of the research group

Asst. Prof. Joshua Lacey specializes in the decarbonization of transportation and power generation through the use of electrification and low- and zero-carbon alternative fuels. He utilizes a variety of experimental and numerical methodologies to characterize the combustion of alternative fuels, and to evaluate the energy efficiency of novel powertrains and propulsion systems. Asst. Prof. Lacey has significant experience with hydrogen engine systems in particular, and more general expertise in the direct-injection of gaseous fuels.

#### Specific hydrogen- related expertise & research topics

- Use of hydrogen for heat and power
- Advanced direct injection strategies for hydrogen in reciprocating engines
- Abnormal combustion limit of hydrogen, hydrogen/natural gas blends
- Flexible oxy-fuel combustors with hydrogen-enrichment
- Combustion of zero carbon fuel blends (ammonia/hydrogen), in-situ cracking of ammonia for hydrogen-enhanced ammonia combustion
- Storage of intermittent, renewable energy using 'green' hydrogen injected into the natural gas network

#### Participating in FL/B/EU funded projects with H<sub>2</sub> related research:

- **BeHyFE** (Belgian Hydrogen Fundamental Expertise), targeting projects for PhD students involving all aspects of the hydrogen value chain (hydrogen production, storage/logistics and end-use), FOD ETF, knowledge institutions and universities throughout Belgium (12 total partners)
- **ICO2CH** (Integrated CO<sub>2</sub> Capture and Hydrogen Production) – novel reactor producing green hydrogen connected to oxy-fuel reciprocating engine valorizing CO<sub>2</sub>/O<sub>2</sub> byproducts, VLAIO Moonshot, VITO/IMEC/VUB/KU Leuven

#### Available equipment/tools:

- 300 kW ABB DC dynamometer
- Engine test bed with suite of instrumentation (i.e. in-cylinder pressure transducers, etc.)
- Flexible swirl burner apparatus
- High-speed image-intensifier and visualization hardware
- Array of mass flow controllers to mix gases for air/partial oxy-fuel/full oxy-fuel combustion
- Electron impact ionization mass spectrometer for H<sub>2</sub> detection
- In-house LabVIEW-based combustion analysis software
- Vehicle powertrain modelling software

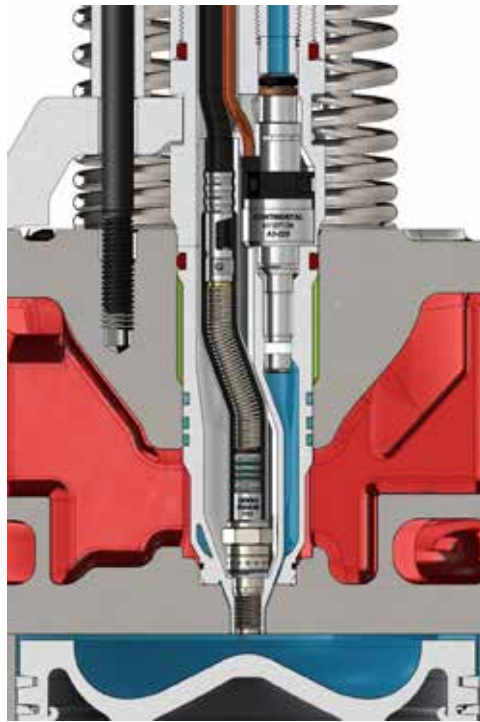

*Previous DI H<sub>2</sub> application in a heavy-duty engine*

#### Main relevant publications

- Joel Mortimer, Farzad Poursadegh, Michael Brear, Stephen Yoannidis, Joshua Lacey, Yi Yang, Extending the knock limits of hydrogen DI ICE using water injection, *Fuel*, 2022.
- M.R. Yosri, J.Z. Ho, M. Meulemans, M. Talei, R.L. Gordon, M.J. Brear, D. Cosby, J.S. Lacey, Large-eddy simulation of methane direct injection using the full injector geometry, *Fuel*, Volume 290, 2021.
- Zhewen Lu, Junqiu Jiang, Yi Yang, Joshua Lacey, Michael J. Brear, Hydrogen oxidation near the second explosion limit in a flow reactor, *Proceedings of the Combustion Institute*, 2020.
- Mortimer, J, Yoannidis, S, Poursadegh, F, Lu, Z, Brear, M, Yang, Y, Etherington, D, Heijkoop, M, & Lacey, J. "An Experimental and Numerical Study of a Hydrogen Fueled, Directly Injected, Heavy Duty Engine at Knock-Limited Conditions." *Proceedings of the ASME 2020 Internal Combustion Engine Division Fall Technical Conference*. ASME 2020 Internal Combustion Engine Division Fall Technical Conference. Virtual, Online. November 4–6, 2020. V001T01A002. ASME.

#### International collaborations:

- University of Melbourne Thermodynamics Laboratory
- Engine Combustion Network (ECN)

#### Contact persons:

Asst. Prof. Joshua Lacey, [josh.lacey@kuleuven.be](mailto:josh.lacey@kuleuven.be)

## *UGent: Applied thermodynamics & heat transfer*

Ghent University, Faculty of Engineering and Architecture

General expertise of the research group:

ATHT specializes in thermodynamics and heat transfer doing experimental and numerical research:

- Heat exchangers
- Two phase flow heat transfer
- Thermal energy storage
- Heat transfer in electrical drives and combustion engines
- Small scale energy production systems like ORCs, fuel cells, cogen,...
- Heating, Ventilation, Air Conditioning & Refrigeration (HVAC&R)
- Energy performance of buildings
- (Residual) heat in industry

Specific hydrogen- related expertise & research topics:

- H<sub>2</sub> compression, liquefiers
- H<sub>2</sub> fuel cells

Available equipment/tools:

- Fuel cell performance testing
- Thermodynamic simulation software
- CFD

International collaborations:

Participating in FL/B/EU funded projects with H<sub>2</sub> related research:

- See website: [research.ugent.be](http://research.ugent.be)



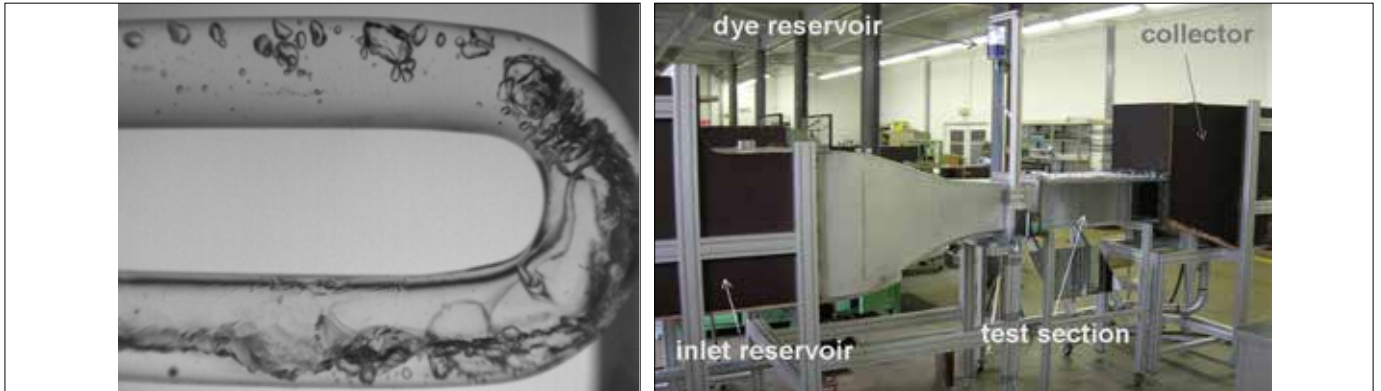

#### Main relevant publications:

- See website: [biblio.ugent.be](http://biblio.ugent.be)
- Verhaert I, Mulder G, De Paepe M. Evaluation of an alkaline fuel cell system as a micro-CHP. ENERGY CONVERSION AND MANAGEMENT. OXFORD: PERGAMON-ELSEVIER SCIENCE LTD; 2016;126:434–45.
- Verhaert I, Verhelst S, Huisseune H, Poels I, Janssen G, Mulder G, et al. Thermal and electrical performance of an alkaline fuel cell. APPLIED THERMAL ENGINEERING. 2012;40:227–35.

#### Contact persons:

Louis Sileghem ([Louis.Sileghem@UGent.be](mailto:Louis.Sileghem@UGent.be))  
Hydrogen Platform Manager UGent  
T +32 496 63 16 01

Prof. Michel De Paepe ([Michel.DePaepe@UGent.be](mailto:Michel.DePaepe@UGent.be))  
Sint-Pietersnieuwstraat 41  
Technicum building 4  
B-9000 Gent  
T: +32 9 264 33 59  
T: +32 9 264 32 88

# 5 Hydrogen general topics

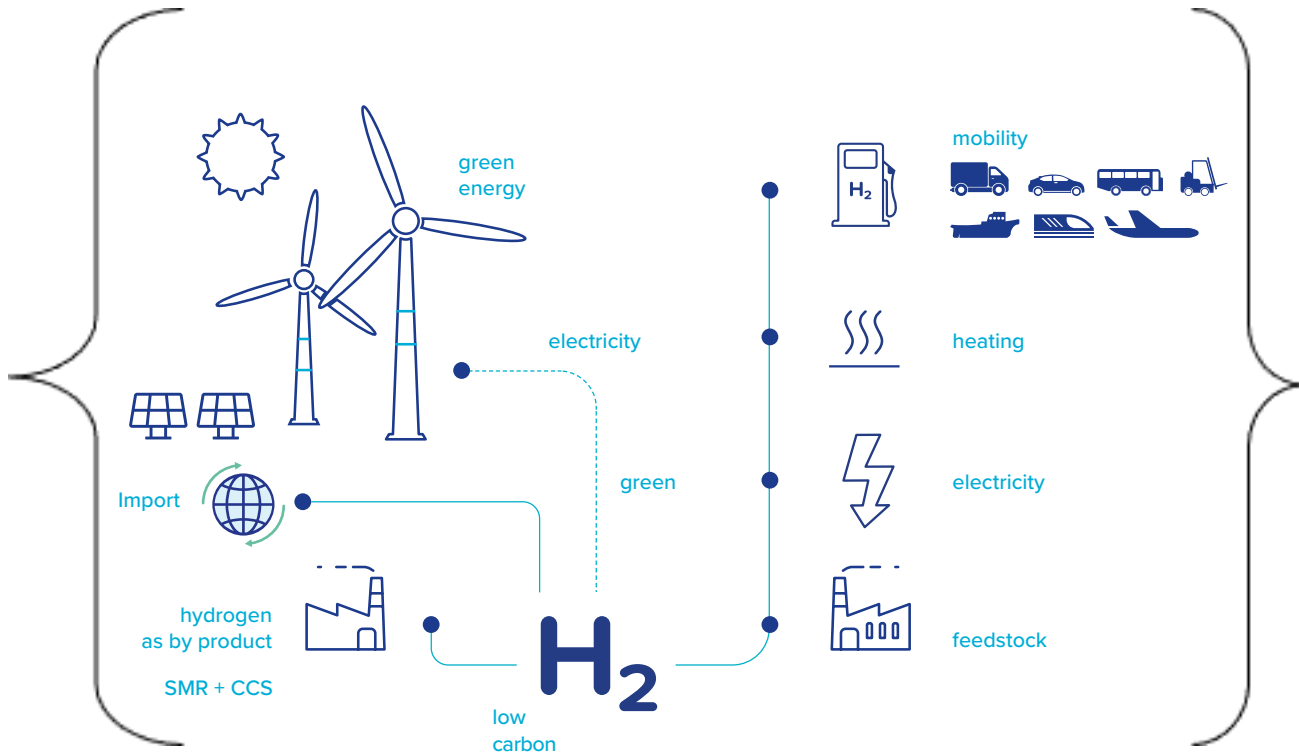

## VUB: Department of Materials and Chemistry MACH/ Research Group Electrochemical and Surface Engineering SURF

### Vrije Universiteit Brussel, Faculty of Engineering Sciences

#### General expertise of the research group

The **Electrochemical and Surface Engineering group (SURF)** has a long tradition in research on electrochemical systems, and is internationally recognized for its expertise in unravelling mechanisms of electrochemical processes related with corrosion and protection, passivation of metals, localized corrosion, surface treatments and coatings. The multidisciplinary research strategy of the group is employed based on complementary macroscopic and local electrochemical methods, own developed computational software for process simulation and in-situ/ex-situ surface analytical techniques. SURF is in the unique position of having advanced research technology in-house and has own infrastructure of about 6 million €. SURF has a large network of companies supporting the research.

#### Specific hydrogen- related expertise & research topics

- Study of the hydrogen-steel interactions from a **SURFACE** perspective: influence of surface state, oxide types.... on the hydrogen-steel interaction mechanisms;
- Use and development of electrochemical methods to study hydrogen-metal interactions at the H-steel surface/interface, based on voltammetry, local methods (e.g. Scanning Kelvin Probe Force Microscopy) etc.;
- Electrochemical modelling of the hydrogen-steel interactions (FEM modelling, in-house developments);
- Electrochemical analysis of new electrode materials for hydrogen fuel cells.

#### International collaborations:

##### Industrial:

- APERAM
- TOYOTA
- AIRBUS

##### Academic:

- Prof. Frédéric Christien, Ecole des Mines, Saint-Etienne, France, for collaboration on Scanning Kelvin Probe Force Microscopy.
- Dr. Lars Jeurgens, EMPA, Switzerland, for micro-capillary cell analysis.

#### Participating in FL/B/EU funded projects with H<sub>2</sub> related research:

- AVN - Association Vinçotte Nuclear, PhD projects, on Surface state impact of hydrogen-steel interactions;
- SBO project DeMoPreCi, SIM Maduros program, on electrochemical permeation modelling;
- FWO fundamental research PhD grant, on Hydrogen in Duplex SS steel.
- Industrial research with Aperam, Toyota, Airbus.

#### Available equipment/tools:

- Materials' surface analyses: XPS, FEG-AES, ToF-SIMS, FEG-SEM/EDX/WDX, Raman, Ellipsometry, FTIR, nano-IR / EIS combination, AFM
- Electrochemical experimental analyses:
  - Macroscopic: polarisation methods (OCP, CV, ...), Impedance spectroscopy (in-house developed ORP-EIS), climate chamber...
  - Microscopic: AFM, SKPFM, SVET, SECM
- Electrochemical FEM modelling (own developed approaches & expertise)

#### Main relevant publications

B. OZDIRIK, K. BAERT, T. DEPOVER, J. VERECKEN, K. VERBEKEN, H. TERRYN, I. DE GRAEVE, 'Development of an Electrochemical Procedure for Monitoring Hydrogen Sorption/Desorption in Steel', JOURNAL OF THE ELECTROCHEMICAL SOCIETY 164(3) (2017) C747-C757.

B. OZDIRIK, T. DEPOVER, L. VECCHI, K. VERBEKEN, H. TERRYN, I. DE GRAEVE, 'Comparison of Electrochemical and Thermal Evaluation of Hydrogen Uptake in Steel Alloys Having Different Microstructures', JOURNAL OF THE ELECTROCHEMICAL SOCIETY 165 (11) (2018) C787-C793.

B. OZDIRIK, T. SUTER, ULRIK HANS, T. DEPOVER, K. VERBEKEN, P. SCHMUTZ, L. P. H. JEURGENS, H. TERRYN, I. D. GRAEVE, 'Study of the hydrogen uptake in deformed steel using the microcapillary cell technique', CORROSION SCIENCE DOI:10.1016/J.CORSCI.2019.04.029.

L. VECCHI, DARJA PEČKO, et al. H. TERRYN, 'Numerical interpretation to differentiate hydrogen trapping effects in iron alloys in the Devanathan-Stachurski permeation cell', CORROSION SCIENCE DOI:10.1016/J.CORSCI.2019.04.008.

L. VECCHI, et al. H. TERRYN, 'Modelling of hydrogen permeation experiments in iron alloys: Characterization of the accessible parameters – Part I – The entry side', ELECTROCHIMICA ACTA 262 (2017) DOI: 10.1016/j.electacta.2017.12.172.

L. VECCHI, et al., 'Modelling of hydrogen permeation experiments in iron alloys: Characterization of the accessible parameters – Part II – The exit side', ELECTROCHIMICA ACTA 262 (2018) 153.

L. CLAEYS, T. DEPOVER, I. DE GRAEVE, K. VERBEKEN, 'Electrochemical hydrogen charging of duplex stainless steel', CORROSION 75(8) (2019) p.880-887.

L. CLAEYS, I. DE GRAEVE, T. DEPOVER, K. VERBEKEN, 'Impact of hydrogen and strain rate on the martensitic transformations and mechanical properties of 304L stainless steel: hydrogen embrittlement or hydrogen enhanced ductility?', ACTA MATERIALIA accepted MSA\_140079.

#### Contact persons:

Iris De Graeve, [iris.de.graeve@vub.be](mailto:iris.de.graeve@vub.be)



Materials &  
components  
development

H<sub>2</sub>-General

## UGent: Mechanical Construction - Soete Laboratory

Ghent University, Faculty of Engineering and Architecture

General expertise of the research group:

At Soete Laboratory, we are pushing the boundaries in fracture mechanics and tribology. As researchers we are active in both experimental and numerical research on fatigue, fracture, friction, wear, reliability and durability of machine parts and mechanical constructions.

Within Soete Laboratory, the fatigue & fracture mechanics research group is headed by Prof. Wim De Waele and Prof. Stijn Hertelé. The activities of the group can be divided into three topics: Fatigue lifetime analysis, joining and additive manufacturing (Prof. De Waele) and quasi-static fracture and damage mechanics (Prof. Hertelé).

Specific hydrogen- related expertise & research topics:

- Effects of hydrogen on mechanical properties of steel (embrittlement), mostly in a transport/storage context (pipelines)
- Effect of hydrogen on accelerated rolling contact fatigue failure of roller bearings

Available equipment/tools:

- Universal test rigs for small- and large scale mechanical testing (up to 8 MN)
- In-house test procedures for advanced mechanical testing (e.g. low-constraint fracture toughness testing)
- Development of material models involving hydrogen diffusion, hydrogen assisted degradation and resulting material damage

International collaborations:-

#### Participating in FL/B/EU funded projects with H<sub>2</sub> related research:

- FWO research project on hydrogen embrittlement
- SIM SBO MaSiWEC
- See website: [research.ugent.be](http://research.ugent.be)



#### Main relevant publications:

- See website: [biblio.ugent.be](http://biblio.ugent.be)
- Depover T, Hertelé S, Verbeken K. The effect of hydrostatic stress on the hydrogen induced mechanical degradation of dual phase steel : a combined experimental and numerical approach. ENGINEERING FRACTURE MECHANICS. 2019;221.

#### Contact persons:

Louis Sileghem ([Louis.Sileghem@UGent.be](mailto:Louis.Sileghem@UGent.be))  
Hydrogen Platform Manager UGent  
T +32 496 63 16 01

Prof. Stijn Hertelé ([Stijn.Hertelé@UGent.be](mailto:Stijn.Hertelé@UGent.be))  
Technologiepark-Zwijnaarde 46  
B-9052 Zwijnaarde

## UGent: Sustainable Materials Science

### Ghent University, Faculty of Engineering and Architecture

#### General expertise of the research group:

The research group Sustainable Materials Science is part of the Department of Materials, Textiles and Chemical Engineering (MaTCh) and has a large amount of experimental and characterization facilities at its disposal. Experimental work is complemented with simulations and modeling efforts. **Main research expertise is the study of the interaction of metallic materials with hydrogen** and how hydrogen impacts the performance of these metals. Apart the work on hydrogen induced degradation, the groups also studies the degradation of metals resulting from interaction with their environment (corrosion processes) and high-temperature metallurgical processes (pyrometallurgy)

#### Specific hydrogen- related expertise & research topics:

The research group has **internationally recognized** expertise in generating high impact research based on **developing experimental methodologies related to hydrogen embrittlement** which are going **beyond the state-of-the-art**. The strategy is to design **innovative experimental set-ups** e.g. by combining different sets of equipment, while keeping in mind the **very specific nature of hydrogen/microstructure interaction** such as the low hydrogen solubility and high hydrogen diffusivity in BCC-steel, whereas hydrogen has a high solubility and low diffusivity in FCC-alloys. For the moment 10 PhD students and two postdocs are working on hydrogen related research topics.

Specific research topics are focusing on the interaction of hydrogen with amongst others wire steels, pipeline steels, bearings, additive manufactured alloys, titanium, tungsten, duplex stainless steels, austenitic stainless steel, automotive steel grades (first, second and third generation advanced high strength steels). Both fundamental and application oriented aspects are highlighted.

The group has a vast amount of knowledge on high-end **material characterization** techniques, **alloy development** and offers an in-depth understanding and expertise on all **metallurgical** phenomena.

#### Participating in FL/B/EU funded projects with H<sub>2</sub> related research:

For the moment, 10 PhD students and 2 postdocs are working on hydrogen related research. Topics include the interaction of hydrogen with amongst others pipeline steels, bearing steels, additive manufactured alloys, titanium, wire steels, duplex stainless steels, austenitic stainless steel, automotive steel grades (first, second and third generation advanced high strength steels). **This work is funded by a wide variety of funding schemes including FWO, SIM, UGent, Vlaio and EU funding**

See also website: [research.ugent.be](http://research.ugent.be)

#### Available equipment/tools:

- thermal desorption spectroscopy
- various equipment and set-ups for electrochemical hydrogen charging and gaseous hydrogen charging via autoclaves
- electrochemical hydrogen permeation, incl. applying mechanical load during permeation test demonstrating effect of mechanical load on hydrogen diffusion coefficient
- diffusion based models
- hot and melt extraction to determine hydrogen content of metal
- various set-ups for in-situ mechanical tests (performing mechanical test while material remains in contact with hydrogen environment). Tests include slow strain rate tensile tests, constant load tests, bending tests, single edge notch tensile tests
- advanced microstructural characterization tools (e.g. for crack initiation and propagation, phase transformation, role of hydrogen on deformation mechanism, identification of hydrides) such as scanning electron microscopy, transmission electron microscopy, electron backscatter diffraction,
- micro-tensile device inside scanning electron microscopy

#### International collaborations:

The group is involved in multiple **international collaborations with academic partners and research institutes**. Demonstrated examples are found in joint work with among others colleagues from NTNU (Norway), MCL Leoben (Austria), TU Graz (Austria), University of Queensland (Australia), Ecole des Mines Saint-Etienne (France), Paristech (France), TUEindhoven (The Netherlands), RWTH Aachen (Germany), Max-Planck Institute für Eisenforschung (Germany), Curtin University (Australia), Kyushu University (Japan),...

Multiple collaborations are ongoing with **international industrial** partners. Due to NDA's, names can however not be revealed.

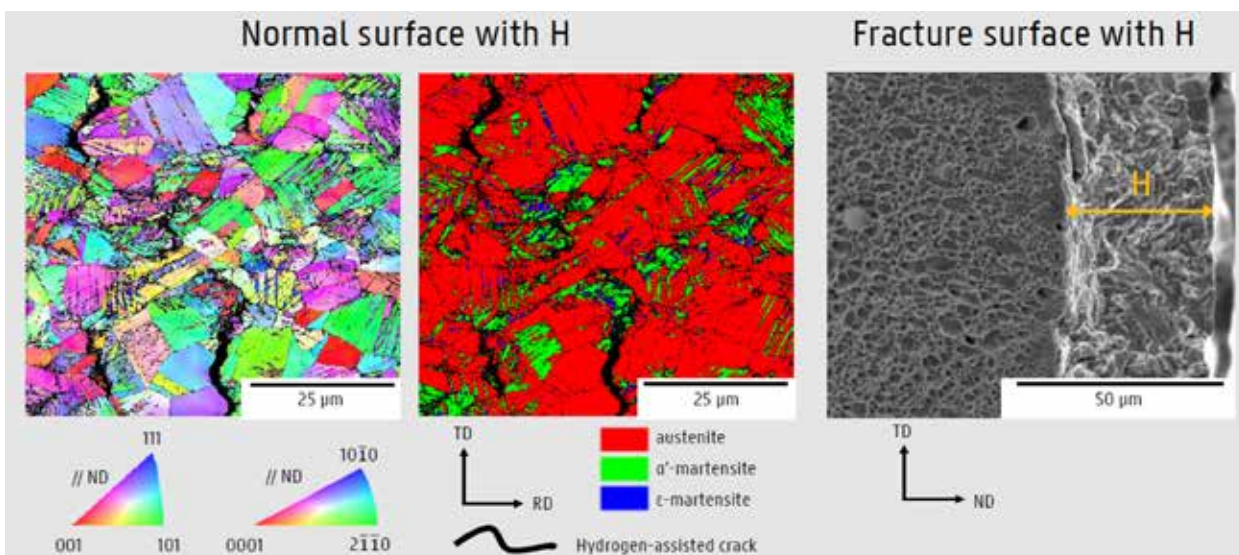



#### Main relevant publications:

- Via the following links for more info as the research group as **over 100 relevant papers**
  - <https://research.ugent.be/web/person/kim-verbeken-1/publications?1>
  - <https://www.ugent.be/ea/match/sms/en>
- **The potential of the internal friction technique to evaluate the role of vacancies and dislocations in the hydrogen embrittlement of steels**, L Vandewalle, M Konstantinovic, T. Depover, K. Verbeken, Steel Research International, 2021, 2100037
- **EBSD characterization of hydrogen induced blisters and internal cracks in TRIP-assisted steel**, A Laureys, M. Pinson, T. Depover, R. Petrov, K. Verbeken, Materials Characterization, 159, 2020, 110029
- **Critical assessment of the evaluation of thermal desorption spectroscopy data for duplex stainless steels: a combined experimental and numerical approach**, L Claeys, V Cnockaert, T. Depover, I. De Graeve, K. Verbeken, Acta Materialia, 186, 2020, 190-198
- **Microstructural based hydrogen diffusion and trapping models applied to Fe-C-X alloys**, A Drexler, T. Depover, S Leitner, K. Verbeken, W Ecker, Journal of alloys and compounds, 826, 2020, 154057
- **Qualification of the in-situ bending technique towards the evaluation of the hydrogen induced fracture mechanism of martensitic Fe-C steels**, M Pinson, T. Depover, H. Springer, K. Verbeken, Materials Science and Engineering A, 792, 2020, 139754
- **The detrimental effect of hydrogen at dislocations on the hydrogen embrittlement susceptibility of Fe-C-X alloys: an experimental proof of the HELP mechanism**, T. Depover, K. Verbeken, International Journal of Hydrogen Energy, 43, 2018, 3050-3061
- **Understanding the interaction between a steel microstructure and hydrogen**, T. Depover, A Laureys, D. Perez Escobar, E. Vanden Eeckhout, E Wallaert, K. Verbeken, Materials, 11, 2018; 698
- **Effect of deformation and charging conditions on crack and blister formation during electrochemical hydrogen charging**, A Laureys, E Van den Eeckhout, R Petrov, K Verbeken, Acta Materialia, 127, 2017, 192-202
- **Fractographic analysis of the role of hydrogen diffusion on the hydrogen embrittlement susceptibility of DP steel**, T. Depover, E. Wallaert; K. Verbeken, Materials Science and Engineering A, 649, 2016, 201-208
- **The effect of TiC on the hydrogen induced ductility loss and trapping behavior of Fe-C-Ti alloys**, T. Depover; K. Verbeken, Corrosion Science, 112, 2016, 308-326,

#### Contact persons:

Louis Sileghem ([Louis.Sileghem@UGent.be](mailto:Louis.Sileghem@UGent.be))

Hydrogen Platform Manager UGent

T +32 496 63 16 01

Prof. dr. ir. Kim Verbeken ([Kim.Verbeken@UGent.be](mailto:Kim.Verbeken@UGent.be))

Prof. dr. ir. Tom Depover ([Tom.Depover@UGent.be](mailto:Tom.Depover@UGent.be))

Tech Lane Ghent Science Park – Campus A

Technologiepark-Zwijnaarde 46

B-9052 Gent



Materials &  
components  
development

H<sub>2</sub> General

## OCAS: Metallurgy department

### OCAS, R&D centre

#### General expertise of the research group

Applied research and development of materials.

Supported by a state-of-the-art lab, OCAS can perform decent metallurgical investigations and testing of materials in different environments with the ability to closely represent the operational circumstances.

Solving questions of customers about material compatibility considering degradation, design life and safety aspects. Ranking of candidate materials, material selection and risk mitigation.

#### Specific hydrogen- related expertise & research topics

- Applied R&D on the interaction between hydrogen and materials.
- Thorough knowledge and understanding of the metallurgical phenomena.
- **Testing**, standard and non-standard test equipment, for determination and understanding of the effect of hydrogen on the material performance under specific conditions and w/o loading: unloaded, static or dynamic loading.
- **Determination of the behaviour of a material** in an environment with presence of hydrogen at certain operating conditions.
- **Modelling** of interaction between hydrogen and materials by empirical testing and numerical simulations. Models to optimise production processes, maintenance schedules and prediction of material/component lifetime in a hydrogen environment.
- **Failure analysis**. During such an analysis, investigation tries to clarify material damage, component failure due to hydrogen-related degradation mechanisms. Expertise on damage triggers such as hydrogen embrittlement and hydrogen induced cracking
- **Material compatibility concerns**. Advise on material selection, material degradation, corrosion and coating related to hydrogen. This advice may result in a **dedicated material program** that **demonstrates material compatibility** with respect to a certain goal. Notified bodies can be involved in such examinations
- Hydrogen testing in **sour environment** (OCAS dedicated H<sub>2</sub>S lab, NACE testing, qualification)
- **National and international exchange** on R&D, organisation of a series of international conferences **Steelyhydrogen** - upcoming 4th ed. 11-13 October 2022: <https://steelyhydrogen.be>

### Available equipment/tools:

All analytical equipment for measuring hydrogen content, in and through materials. OCAS is accredited for a series of analyses and qualified to work with deuterium.

- Equipment for charging: electrolytical or autoclave
- Equipment for H determination (hot and melt extraction)
- Equipment for H diffusion and permeation
- Thermal desorption
- Equipment for Microstructural investigation

### Mechanical testing:

- Constant load
- Slow and high strain rate testing
- Disc rupture testing
- Fracture mechanics
- Fatigue testing

Equipment for NACE testing (H<sub>2</sub>S)

### International collaborations:

OCAS mainly works on a bilateral agreement between national or international customers. Different extends are possible, from a single measurement up to a dedicated research program. OCAS aims to accelerate the R&D at the customer, giving support by sharing competences and specific equipment.

### Participating in FL/B/EU funded projects with H<sub>2</sub> related research:

- Open to collaborate in funded projects
- IPCEI H<sub>2</sub>
- **FORGE** - Development of novel coating materials for a sustainable future (Evaluation of hydrogen pick up and hydrogen embrittlement) - H2020-NMBP-ST-IND-2018-2020.
- **HYDRO-REAL** - Study the sensitivity of ultra-high strength cold rolled steels to hydrogen embrittlement - RFCS-02-2019
- **INiTiAl** - Advanced implementation of novel corrosion resistant high strength maraging steels with improved process robustness via tuned intermetallic nano-precipitation - RFCS-02-2017
- **Charge & Load** - Hydrogen embrittlement and delayed fracture of advanced multiphase high-strength steels - RFSR-CT-2006-00025
- **HYDRAMICROS** - Hydrogen sensitivity of different advanced high strength microstructures - RFSR-CT-2010-00020
- **SUPERHIGH** - In-use properties of Super High strength steels generated by a range of metallurgical strategies RFCS-PR-12161

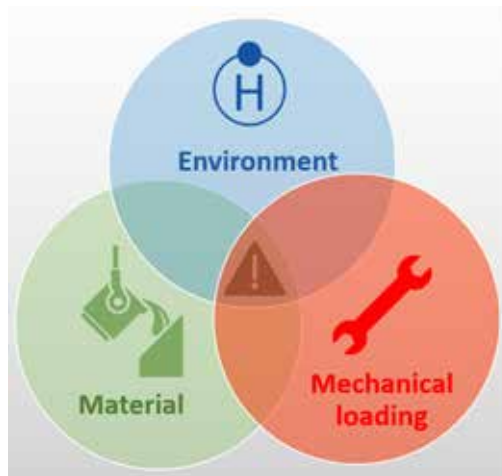

### Main relevant publications

- Investigation of hydrogen trapping in retained austenite via deuterium charging at high temperature. L Moli-Sanchez, Z Zermout, L Duprez. Proceedings 3rd International Conference on Metals and Hydrogen, May 2018, Ghent, Belgium
- Hydrogen embrittlement of 4 martensitic steels with strength levels above 1000 MPa. L. Moli-Sanchez, Z. Zermout, L. Duprez, L. Malet. (Proceedings SteelyHydrogen 2014)
- Effect of in-situ hydrogen charging on the mechanical properties of advanced high strength steels. T. Depover, D. Pérez Escobar, E. Wallaert, Z. Zermout. International Journal of Hydrogen Energy. Vol. 39 (2014) pp. 4647–4656
- Hydrogen embrittlement in various steels with strength levels above 1000 MPa. L Duprez, M Arafin, F Van den Abeele, N Bernier. Joint HYDROGENIUS and I2CNER International Workshop on Hydrogen-Materials Interactions 2012 Kyushu University
- Combined thermal desorption spectroscopy, differential scanning calorimetry, scanning electron microscopy and X-ray diffraction study of hydrogen trapping in cold deformed TRIP steel. D. Perez Escobar, T. Depover, L Duprez, K. Verbeken and M. Verhaege. (2012) ACTA MATERIALIA. 60(6-7). p.2593-2605
- Thermal desorption spectroscopy study of the interaction between hydrogen and different microstructural constituents in lab cast Fe-C alloys. D. Pérez Escobar, T. Depover, E. Wallaert, L. Duprez, M. Verhaege, K. Verbeken. Corrosion Science. Vol. 65 (2012) pp. 199-208
- Evaluation of hydrogen trapping in high strength steels by thermal desorption spectroscopy. D. Perez Escobar, K Verbeken, L Duprez, M Verhaege (2012) MATERIALS SCIENCE AND ENGINEERING A-STRUCTURAL MATERIALS PROPERTIES MICROSTRUCTURE AND PROCESSING. 551. p.50-58
- Internal and surface damage of multiphase steels and pure iron after electrochemical hydrogen charging. D Perez Escobar, C Minambres, L Duprez, K Verbeken, M Verhaege (2011) CORROSION SCIENCE. 53(10). p.3166-3176
- Selecting hydrogen embrittlement resistant materials by means of the disc rupture test. Elke Leunis, Lode Duprez. 18th World Hydrogen Energy Conference 2010, Essen / Germany

### Contact persons:

[Steven.keyzer@ocas.technology](mailto:Steven.keyzer@ocas.technology)

[Philippe.thibaux@ocas.technology](mailto:Philippe.thibaux@ocas.technology)



Materials &  
components  
development

H<sub>2</sub> General

## OCAS: Department applications and solutions

### OCAS, R&D centre

#### General expertise of the research group

Applied research and development on the behaviour of components and structures. Expertise about modelling hydrogen diffusion in 3D component, analysis of stress-states and prediction of life time. Testing of components on a small test bench (mock-up) or on large scale, real size testing rigs, also enabling qualification testing. Harvesting of data for condition monitoring and deep digital analyses (AI, digital twin). Acceptance testing (pass/fail testing).

#### Specific hydrogen- related expertise & research topics

- Applied R&D on the interaction between hydrogen and materials.
- Thorough knowledge and understanding of the metallurgical phenomena.
- **Testing**, standard and non-standard test equipment, for determination and understanding of the effect of hydrogen on the performance of components and structures under specific conditions and w/o loading: unloaded, static or dynamic loading.
- Determination of the behaviour of a **component or structure** in an environment with presence of hydrogen at certain operating conditions.
- **Modelling** of interaction between hydrogen and materials by empirical testing and numerical simulations. Models to optimise production processes, maintenance schedules and prediction of material/component lifetime in a hydrogen environment.
- OCAS differentiates by focussing on **large scale testing**, test setups that cannot be performed in normal-sized labs, considering **real operating conditions and safety aspects of the bigger industrial installations and infrastructure**.
- **Building of specific test equipment for testing under high pressure** (including hydrogen, pure or blend) exposing materials and/or components. This service comprises the **design and assembly of tailor-made test rigs** for multipurpose i.e. focussing on a specific component of which **the fitness-for-purpose** of the design is assessed with respect to a certain **application, operating conditions and safety aspects**.
- Assessment of pass / fail criteria on re-purposing assets such as **pipelines and pressure vessels** towards using hydrogen as **transport or storage** medium.
- Acceptance testing on fit for use aspects of **seals** (threaded metal-to-metal and other) in combination with different mixtures of hydrogen towards transmission, storage and end-use applications (e.g. downhole, pipeline, pressure vessel, gas bottle, connections, ... )

#### Available equipment/tools:

All analytical equipment for measuring hydrogen content, in and through materials. OCAS is accredited for this analysis and qualified to work with deuterium.

- See equipment as specified in section “Metallurgy department”
- Specialised software and modelling tools
- Upscale fatigue bench for large scale components or structures
- Heavy testing bench with possibilities for external and internal loading (installed in pressure pit)
- New to build, tailor-made test rigs for customer dedicated projects

#### International collaborations:

OCAS mainly works on a bilateral agreement between national or international customers. Different extends are possible, from a single measurement up to a dedicated research program. OCAS aims to accelerate the R&D at the customer, giving support by sharing competences and specific equipment.

#### Participating in FL/B/EU funded projects with H<sub>2</sub> related research:

- Open to collaborate in funded projects
- IPCEI H<sub>2</sub>



#### Main relevant publications

See an excerpt of OCAS publications in section “Metallurgy department”

#### Contact persons:

[Steven.keyzer@ocas.technology](mailto:Steven.keyzer@ocas.technology)

[Philippe.thibaux@ocas.technology](mailto:Philippe.thibaux@ocas.technology)



Materials &  
components  
development

H<sub>2</sub> General

## OCAS: Department surface engineering

### OCAS, R&D centre

#### General expertise of the research group

At the department of surface engineering, OCAS focusses on applied research and development concerning surface preparation, coating processes, morphologies, and other surface aspects such as corrosion.

Supported by a state-of-the-art lab, OCAS can perform a full characterisation of surfaces besides several tools for testing surface properties and performing surface exposure and accelerated degradation tests.

On the semi-industrial plating line (electrodeposition), OCAS can make samples for customers and assist in projects looking to, e.g.: alternative electrolytes, optimisation of process parameters or improvement of coating morphology including all related analyses thereof.

#### Specific hydrogen- related expertise & research topics

- **Applied R&D** on the interaction between hydrogen and materials.
- Thorough **knowledge and understanding** of the metallurgical phenomena.
- **Modelling** of interaction at the interface of hydrogen and substrate material: diffusion, adsorption kinetics, saturation.
- Numerical simulations for prediction of **lifetime** in a hydrogen environment.
- Coatings for **H-barriers**
- **Corrosion testing** in hydrogen related circumstances
- Hydrogen ingress during electrochemical coating processes (**Process simulations on electroplating pilot line**: <https://vimeo.com/458463355>)
- Hydrogen effusion from substrate materials during degassing
- **Enamelling** and hydrogen-related issues (fish scale)

#### Available equipment/tools:

All analytical equipment for measuring hydrogen content, in and through materials. OCAS is accredited for this analysis and qualified to work with deuterium.

- See equipment as specified in section “Metallurgy department”
- State of the art lab for surface characterisation
- Techniques for appearance, roughness, hardness, 2D/3D-topography, ...

### International collaborations:

OCAS mainly works on a bilateral agreement between national or international customers. Different extends are possible, from a single measurement up to a dedicated research program. OCAS aims to accelerate the R&D at the customer, giving support by sharing competences and specific equipment.

### Participating in FL/B/EU funded projects with H<sub>2</sub> related research:

- Open to collaborate in funded projects
- IPCEI H<sub>2</sub>
- **FORGE** - Development of novel coating materials for a sustainable future (Evaluation of hydrogen pick up and hydrogen embrittlement) - H2020-NMBP-ST-IND-2018-2020.

### Main relevant publications

See an excerpt of OCAS publications in section “Metallurgy department”

### Contact persons:

[Steven.keyzer@ocas.technology](mailto:Steven.keyzer@ocas.technology)

[Philippe.legros@ocas.technology](mailto:Philippe.legros@ocas.technology)



## *KU Leuven: Dept. Materials Engineering/ Surface and Interface Engineered Materials (New Materials / iR)*

### KU Leuven – Brugge, Materials Engineering

#### General expertise of the research group

The New Materials / iR group at KU Leuven – Brugge concentrates on the experimental development, using chemical synthesis methods and interface modification techniques, and characterization of novel functional (polymer) materials for sustainable solutions in various applications.

#### Specific hydrogen- related expertise & research topics

- Material surface area characterization by gas adsorption techniques
- Underground hydrogen gas storage in rock salt caverns
- Polymer membrane development
- Characterization of degradation of polymer membranes
- Electrochemistry

#### Participating in FL/B/EU funded projects with H<sub>2</sub> related research:

- HYDE: Hydrogen technology for Defence applications, DEFRA Belspo. Partners: KU Leuven, VIVES Zuid, VIVES Noord, Solenco Power

#### Available equipment/tools:

- Electrochemical equipment (Metrohm Autolab potentiostat/galvanostat with impedance station and NOVA2 software)
- Electrosynthesis equipment (ElectraSyn)
- Automated film applicator
- Spin coater, dip coater, spray coater
- Fumehoods and chemical synthesis equipment, autoclaves, ovens, centrifuge, etc
- Ultrasonic probe
- Tube furnace
- Ion chromatograph
- Viscometer
- Pull-off adhesion tester

### Main relevant publications

- Madhav, D., Shao, C., Mus, J., Buyschaert, F., Vandeginste, V. (2023). The effect of salty environments on the degradation behaviour and mechanical properties of Nafion membranes. *Energies*.
- Vandeginste, V., Ji, Y., Buyschaert, F., Anogiatis, G. (2023). Mineralogy, microstructures and geomechanics of rock salt for underground gas storage. *Deep Underground Science and Engineering*.
- Xie, W., Wang, M., Vandeginste, V., Chen, S., Yu, Z., Wang, J., Wang, H., Gan, H. (2022). Adsorption behavior and mechanism of CO<sub>2</sub> in the Longmaxi shale gas reservoir. *RSC ADVANCES*, 12 (40), 25947-25954.
- Martin-Clave, C., Ougier-Simonin, A., Vandeginste, V. (2021). Impact of second phase content on rock salt rheological behaviour under cyclic mechanical conditions. *Rock Mechanics and Rock Engineering*, 54, 5245-5267.

### Contact persons:

Prof. Veerle Vandeginste  
[veerle.vandeginste@kuleuven.be](mailto:veerle.vandeginste@kuleuven.be)

KU Leuven – Brugge  
Spoorwegstraat 12  
8200 Brugge

## Sirris: Harsh environments

### Harsh environments

#### General expertise of the research group

- In general: Mechanical and climatic environmental testing (lab test & field testing) of machinery installed in remote locations with (extreme) harsh weather conditions (deserts, cold climates, offshore) with the aim to validate prototypes and prove reliability in harsh conditions. Main aim is to provide data, insights and understanding for product CAPEX and OPEX optimization trajectories.
- Climatic test and validation of large & heavy machinery in harsh environments (system testing) in large climatic test lab.
- Onshore and offshore in-field test & measurements -> vibrations, shocks, climatic conditions, sound...

#### Specific hydrogen- related expertise & research topics

- Fuel cell component or system reliability testing in harsh environments
- Electrolyzer component or system reliability testing in harsh environments
- Power unit components (Rectifier, convertor and transformer) reliability testing in harsh environments
- Storage tank testing under harsh climatic conditions

#### Available equipment/tools:

- Large climatic test chamber (10.6m x 7m x 8m) ; -60°C to +60C conditions, high humidity, icing conditions <https://www.sirris.be/largest-climatic-test-chamber-in-europe> + different system test set-ups (flexible power set-ups to perform functional system testing under climatic conditions)
- Different lab and in-field test & measurement DAQ and sensor set-ups for R&D measurement campaigns

#### Participating in FL/B/EU funded projects with H<sub>2</sub> related research: /



#### Main relevant publications

- Transformers Mag., 2(2), 28–35. Jordaens, P. J., Cloet, B., Nuri, J., Van Schevensteen, R. (2015): Cold start of a 5.5MVA offshore transformer.
- P. Jordaens, “Why performing climate chamber tests for wind energy applications?,” OWI-Lab, 2014.
- P. Jordaens, “Cold climate issues for wind turbine machinery,” Windtech International magazine, vol. 2, no. 1, pp. 17-19, 2015.

#### International collaborations:

The test facility for harsh environments is working for either Belgian and International customers. Examples of international collaborations: ABB, Siemens, Siemens-Gamesa, SGB-SMIT, Engie-Laborelec

#### Contact persons:

[Pieterjan.jordaens@sirris.be](mailto:Pieterjan.jordaens@sirris.be) | [Bram.cloet@sirris.be](mailto:Bram.cloet@sirris.be)



## *KU Leuven: Department of Mechanical Engineering/ Energy Systems Integration and Modeling (ESIM) Research Group*

### KU Leuven, Engineering Science

#### General expertise of the research group

Research focus and expertise is on quantitative tools, supporting an efficient operation of, and transition towards, a low-carbon energy system (mathematical modeling of energy systems). A major strength of the group is its interdisciplinary focus (techno-economic models considering multiple energy vectors, link to energy markets and policies). Modeling focus is on unit commitment models, generation expansion planning models, equilibrium models and agent-based models. Applications relate to flexibility through energy systems integration, market design, renewables support mechanisms and emission trading.

#### Specific hydrogen- related expertise & research topics

- Integrated energy systems modelling
  - Including natural gas networks, gas flows, P2G
  - Long term (seasonal) storage modelling
  - Interactions between electricity and gas sector
- Policy impact assessment
  - Interaction with, e.g., emission trading system (EU ETS)

#### Participating in FL/B/EU funded projects with H<sub>2</sub> related research:

- 2020-2025 PROCURA - Power to X and Carbon Capture & Utilization Roadmap for Belgium – Energy Transition Fund Belgium

#### International collaborations:

- Hydrogen workgroup in EERA Joint Program on Energy Systems Integration

### Main relevant publications

- Mertens, T., Bruninx, K., Duerinck, J., Delarue, E. (2021). Capacity credit of storage in long-term planning models and capacity markets. *Electric Power Systems Research*, 194, Art.No. 107070.
- Belderbos, A., Bruninx, K., Delarue, E., D'haeseleer, W. (2020). Facilitating renewables and power-to-gas via integrated electrical power-gas system scheduling. *Applied Energy*, 275, Art.No. 115082.
- Belderbos, A., D'haeseleer, W. (sup.), Delarue, E. (cosup.) (2019). Storage via Power-to-Gas in Future Energy Systems: The Need for Synthetic Fuel Storage in Systems with High Shares of Intermittent Renewables. PhD Thesis, KU Leuven, Leuven, Belgium.
- Belderbos, A., Delarue, E., Kessels, K., D'haeseleer, W. (2017). Levelized Cost of Storage - Introducing Novel Metrics. *Energy Economics*, 67, pp. 287-299.
- Belderbos, A., Virag, A., D'haeseleer, W., Delarue, E. (2017). Considerations on the need for electricity storage requirements: Power versus energy. *Energy Conversion and Management*, 143, 137-149.
- Vandewalle, J., D'haeseleer, W. (supervisor) (2014). Natural Gas in the Energy Transition - Technical challenges and opportunities of natural gas and its infrastructure as a flexibility-providing resource. PhD Thesis, KU Leuven, Leuven, Belgium.
- Vandewalle, J., Bruninx, K., D'haeseleer, W., 2015. Effects of large-scale power to gas conversion on the power, gas and carbon sectors and their interactions. *Energy Conversion and Management*, vol. 94, pp 28-39.

### Available equipment/tools:

- Optimization models for the operation of energy systems (e.g., using Mixed Integer Linear Programming - MILP).
- Optimization models for energy planning and scenario analyses.
- Equilibrium models describing the interactions of various (market) actors in the liberalized electric power sector (e.g., consumers, generators, system operators).
- Agent-based models to describe the electricity system as a complex adaptive system. This modeling approach captures the complex interactions among the physical infrastructure, the actors' behavior, and the institutions that govern those behaviors in an energy system.
- All of the above can be combined with various policy instruments.

### Contact persons:

- Kenneth Bruninx [kenneth.bruninx@kuleuven.be](mailto:kenneth.bruninx@kuleuven.be)
- Erik Delarue [erik.delarue@kuleuven.be](mailto:erik.delarue@kuleuven.be)
- William D'haeseleer [william.dhaeseleer@kuleuven.be](mailto:william.dhaeseleer@kuleuven.be)

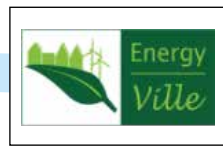

System Modelling  
Economics aspects

General – (Production  
and use cases)

## VITO: Techno-economic assessments and LCA analysis

### VITO/EnergyVille – Unit SCT and SEB

#### General expertise of the research group

VITO is a leading European independent research/consultancy center in the areas of cleantech and sustainable development, elaborating solutions for the grand societal challenges of tomorrow: climate change, food security, a sustainable energy supply, the ageing population and scarcity of resources. Within several units VITO combines the competences to perform techno-economic assessments and life cycle assessments (LCA and LCC) of the hydrogen value chain. With our developed models we can execute these assessments on the micro/meso/macro scale from a specific project/technology and upscale to the energy system covering energy supply and demand sectors.

#### Specific hydrogen- related expertise & research topics

- PhD research project (BE-HyFE) focusing on the development of an investment and operational optimization modelling framework for the future hydrogen infrastructure. The model represents the hydrogen-related supply technologies and pure hydrogen gas flows with high spatial resolution (in the level industrial clusters) to deliver some insights on the cost-optimal required hydrogen backbone capacity, and how different policies can affect the industrial hydrogen production and demand.
- The TIMES-BE model developed by VITO/EnergyVille represents the Belgian energy system including all related technologies and their corresponding material and energy flows. The model is developed in TIMES, a techno-economic energy system modelling framework. Due to its detailed system perspective, the TIMES-Be model is useful for determining hydrogen applications at system level:
  - TIMES will indicate the cost-optimal route in terms of technology investments. Due to the **high level of industrial process detail**, the model allows for hydrogen applications to be compared to its possible future competitors.
  - The TIMES-BE model has an **integrated system approach**, meaning that the interaction between sectors is considered in the analysis. The TIMES-BE model was developed under **close collaboration between industry and researchers**, allowing for detailed insights regarding industrial needs.

#### Available equipment/tools:

Techno-economic assessment model developed in house

- LCC models
- LCA models
- Long-term energy system optimisation model: TIMES (co-development within IEA-ETSAP technology collaboration programme)

### International collaborations:

- VITO NDC Support Center: the NDC Support Center provides support to increase capacity of African countries to improve their National Energy Information Systems and their energy modelling expertise, to prepare climate communication and to improve policy-making in the framework of commitments as set for the Paris Agreement. The NDC Support Center is currently active in Malawi, Mozambique, Uganda, and Morocco.
- Colombia NDC Update: The World Bank's PMR fund contracted VITO's consortium in 2020 to update Colombia's NDC. The consortium, including UniAndes and the Stockholm Environmental Institute, updated & consolidated sector GHG emission scenarios and assessed associated abatement costs.
- Horizon Europe Water-Energy-Food Nexus: WEF Energy Planning and Modelling through Integrated Assessment of Climate-Land-Energy-Water Nexus in Sub-Saharan Africa: The Cases of the Volta and Tana River Basins
- The other flagship World Bank project in which VITO is leading the consortium focuses on conducting a comprehensive technical assessment of resilience to disasters, climate change risks and related GHG emissions intensity for the city of Ahmedabad and providing assistance to the Ahmedabad Municipal Corporation (AMC) in developing resilient and sustainable urban service delivery systems. This project got further extension in 2022 to also include the non-AMC (private) sectors as part of the GHG emissions inventory.

### Participating in FL/B/EU funded projects with H<sub>2</sub> related research:

Energy transition funds projects EPOC and PROCURA focus on the role of hydrogen in the industrial and energy system. Recently, the Paths2050 study, funded by Febeliec published results on the cost optimal pathways for the Belgian energy system, including the role of hydrogen, in [www.perspective2050.energyville.be](http://www.perspective2050.energyville.be).

In addition, last year two projects were carried out for DG Reform:

- One project discussed IPCEI regulation on hydrogen networks,
- The other project investigated policies to implement RepowerEU, and an in-depth report on hydrogen regulation and impact on the federal hydrogen strategy was delivered.

In both projects Trinomics was in the lead, EnergyVille provided the hydrogen techno-economic analysis. Expected publication date is March 2023.



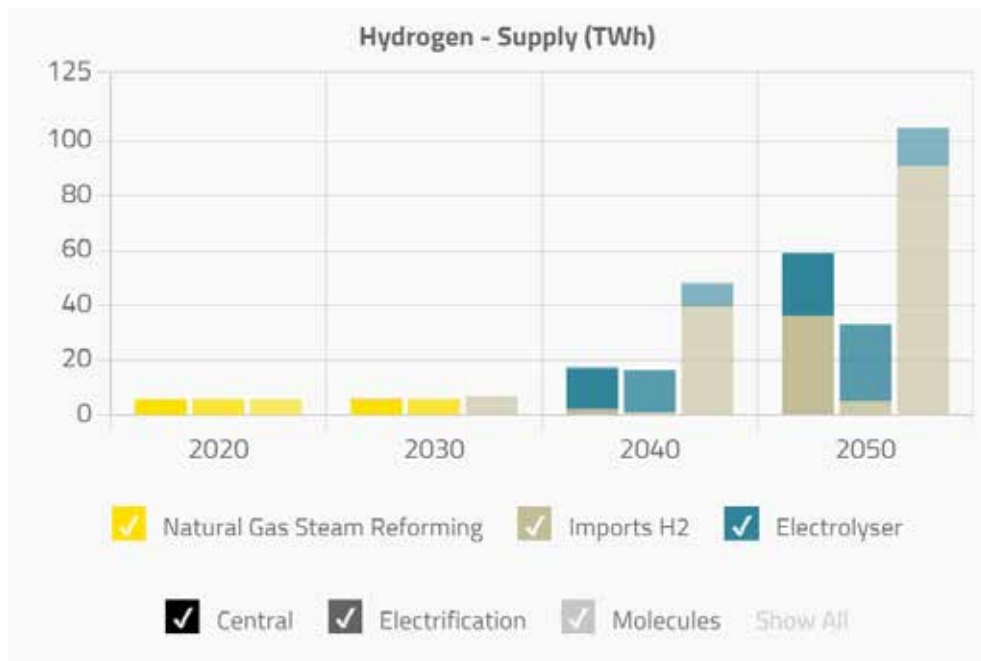

Figure 1. The hydrogen supply in the BE-TIMES study [www.perspective2050.energyville.be](http://www.perspective2050.energyville.be)

#### Main relevant publications

[www.perspective2050.energyville.be](http://www.perspective2050.energyville.be) contains the most relevant TIMES related results of the past year, including a topic on hydrogen.

#### Contact persons:

LCA: [Carolin.Spirinckx@vito.be](mailto:Carolin.Spirinckx@vito.be)

TEA: [Miet.Vandael@vito.be](mailto:Miet.Vandael@vito.be)

Long-term modelling: [Pieter.Lodewijks@vito.be](mailto:Pieter.Lodewijks@vito.be)

[Pieter.vingerhoets@energyville.be](mailto:Pieter.vingerhoets@energyville.be)

## *UGent: Sustainable Systems Engineering (STEN)*

### Ghent University, Faculty of Bioscience Engineering

#### General expertise of the research group:

The Research Group Sustainable Systems Engineering (STEN) aims at designing and evaluating systems in a sustainability context, relying on engineering principles. Products, processes, supply chains, and production and consumption patterns are studied with:

- a focus on resources, i.e. resource footprint and resource efficiency
- a lifecycle thinking approach, e.g. operationalized through MFA and LCA
- thermodynamic principles, relying on the second law: exergy and exergetic life cycle analysis

The research is in close collaboration with national and international universities, research centers, policy makers and industry in areas of the following nature: chemical, pharma, primary raw materials, waste-as-a-resource, agro-bio-food ...

#### Specific hydrogen- related expertise & research topics:

- LCA of e-fuels
- resource footprint
- resource efficiency

#### Participating in FL/B/EU funded projects with H<sub>2</sub> related research:

- S2Chemicals (NL)
- CCU Hub
- See website: [research.ugent.be](https://research.ugent.be)

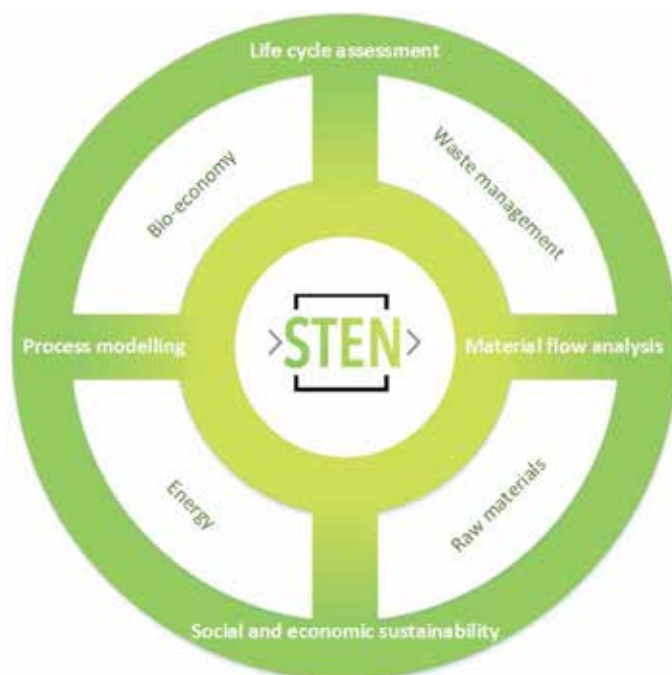

#### Main relevant publications:

- See website: [biblio.ugent.be](http://biblio.ugent.be)
- Huysman S, Sala S, Mancini L, Ardente F, Freitas de Alvarenga R, De Meester S, et al. Toward a systematized framework for resource efficiency indicators. *RESOURCES CONSERVATION AND RECYCLING*. 2015;95:68–76.
- Buchmayr A, Verhofstadt E, Van Ootegem L, Sanjuan Delmas D, Thomassen G, Dewulf J. The path to sustainable energy supply systems : proposal of an integrative sustainability assessment framework. *RENEWABLE & SUSTAINABLE ENERGY REVIEWS*. 2021;138.

#### Contact persons:

Louis Sileghem ([Louis.Sileghem@UGent.be](mailto:Louis.Sileghem@UGent.be))  
 Hydrogen Platform Manager UGent  
 T +32 496 63 16 01

Prof. Jo Dewulf ([Jo.Dewulf@UGent.be](mailto:Jo.Dewulf@UGent.be))  
 Campus Coupure  
 Coupure Links 653, 9000, Gent

Room 38.11.150.018 (Building B - 5th floor)

Tel: +32 (0)9 264 59 50  
 F +32 9 264 49 96

## *VKI: Research Expertise Group on Environmental Flows & Safety; Research Expertise Group on Industrial Flows*

### von Karman Institute for Fluid Dynamics / Environmental & Applied Fluid Dynamics Department

#### General expertise of the research group

Numerical simulation, Computational Fluid Dynamics (CFD) and experimental testing for industrial and environmental hydrogen flows and for safety analysis for hydrogen applications.

#### Specific hydrogen- related expertise & research topics

- Safety:
  - detonation risk
  - risk mitigation of explosions
  - leakage
- Industrial application:
  - cooling of steel with hydrogen

#### Available equipment/tools:

- Software platforms for CFD
  - OpenFOAM®
  - WRF
  - High Performance Computing (HPC) cluster
- Testing facilities
  - Water Spray Facility: The Water-Spray facility is designed for the general study of liquid sprays that are generated by pneumatic and pressure nozzles. It is equipped with a pump capable of delivering spray flow rates up to 1 dm<sup>3</sup>/s at a pressure of 8 bar, with metering of both flow rate and feed pressure, into a 3x4 m<sup>2</sup> collecting pool. The facility is also equipped with a set of gas burners and vertical flat plates, which are instrumented with thermocouples and radiometers, to simulate thermal shielding by a water curtain.

#### International and Industrial collaborations:

- Arcelor Mittal
- Total
- Solvay
- GDF Suez

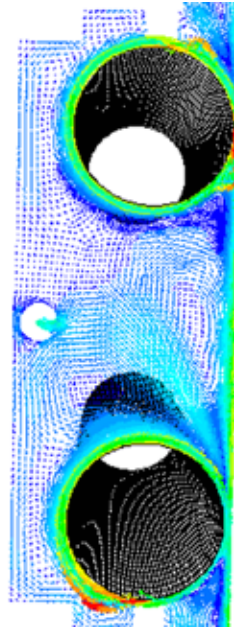
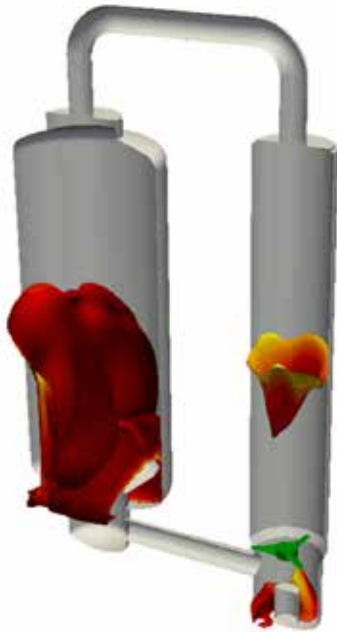

*Left: CFD Simulation of inflammation / combustion of H<sub>2</sub>.  
Right: Use of H<sub>2</sub> for cooling application in steel manufacturing*

#### Contact persons:

- Philippe Planquart – Research Manager EA Department
- Prof. Delphine Laboureur – Head of Research Expertise Group
- Peter Simkens – Business Development Manager

## UGent: Center for Microbial Ecology and Technology

### Ghent University, Faculty of Biosciences Engineering

#### General expertise of the research group:

The Center for Microbial Ecology and Technology (CMET) is a part of the Faculty of Bioscience Engineering at Ghent University. CMET is specialized in the study and application of mixed microbial cultures or communities and the development of technology in a context of wastewater treatment, bioproduction and others. CMET researchers focus on the one hand on the optimal management of microbial resources, on the other hand (supporting) technologies such as (bio)electrochemical systems and monitoring systems are under development.

#### Specific hydrogen- related expertise & research topics:

- Applied Microbial Ecology
- Microbial Monitoring
- Microbial CO<sub>2</sub> conversions
- H<sub>2</sub> upgrading
- Hydrogen driven microbiological processes: Exploring possibilities of the microbial hydrogen metabolism to produce microbial protein (feed and food for the future), to bioremediate pollutants in (waste)water, to remove nutrients for the enhancement of drinking water biostability, ...

#### Available equipment/tools:

- (Online) microbial analysis, based on single cell and molecular principles
- Bacterial isolation, cultivation, characterisation and ecosystem assembly
- (Bio)Reactor systems
- Pilot scale systems
- Biomass synthesis
- Standard chemical analysis (GC, IC, HPLC, ...)

#### Participating in FL/B/EU funded projects with H<sub>2</sub> related research:

- CO2Perate
- Baekelandt project
- FWO-SB and HEC scholarship on high-rate hydrogen-driven bioprocess for CO<sub>2</sub> bioconversions
- H2020 project Electra
- FWO-SB & SBO project Biostable on drinking water stability
- SBO project MicroDetox on micropollutant removal
- See website: [research.ugent.be](http://research.ugent.be)



### Main relevant publications:

- See website: [biblio.ugent.be](http://biblio.ugent.be)
- De Vrieze J, Verbeeck K, Pikaar I, Boere J, Van Wijk A, Rabaey K, et al. The hydrogen gas bio-based economy and the production of renewable building block chemicals, food and energy. *NEW BIOTECHNOLOGY*. 2020;55:12–8.
- Barbosa RG, van Veelen HPJ, Pinheiro V, Sleutels T, Verstraete W, Boon N. 2021. Enrichment of Hydrogen-Oxidizing Bacteria from High-Temperature and High-Salinity Environments. *Applied and Environmental Microbiology* 87.(Impact factor: 4,016; Quantile: Q1)
- PrévotEAU A, Carvajal-Arroyo J, Ganigué R, Rabaey K (2020) Microbial electrosynthesis from CO<sub>2</sub>: forever a promise? *CURRENT OPINION IN BIOTECHNOLOGY*, 62, 48-57. IF 2019: 8.288;
- Hu XN, Kerckhof FM, Ghesquiere J, Bernaerts K, Boeckx P, Clauwaert P, Boon N. 2020. Microbial Protein out of Thin Air: Fixation of Nitrogen Gas by an Autotrophic Hydrogen-Oxidizing Bacterial Enrichment. *Environmental Science & Technology* 54:3609-3617.(Impact factor: 7,149; Quantile: Q1)
- Barbosa RG, Sleutels T, Verstraete W, Boon N. 2020. Hydrogen oxidizing bacteria are capable of removing orthophosphate to ultra-low concentrations in a fed batch reactor configuration. *Bioresource Technology* 311.(Impact factor: 6,669; Quantile: Q1)
- Ehsani E, Dumolin C, Arends JBA, Kerckhof FM, Hu XN, Vandamme P, Boon N. 2019. Enriched hydrogen-oxidizing microbiomes show a high diversity of co-existing hydrogen-oxidizing bacteria. *Applied Microbiology and Biotechnology* 103:8241-8253.(Impact factor: 3,67; Quantile: Q2)
- Ramio-Pujol S, Ganigué R, Baneras LI, Colprim J (2018) Effect of ethanol and butanol on autotrophic growth of model homoacetogens. *FEMS MICROBIOLOGY LETTERS*, 365 (10), fny084. IF 2017: 1.735;
- Puig S, Ganigué R, Batlle-Vilanova P, Balaguer MD, Bañeras LI, Colprim J (2017) Tracking bio-hydrogen-mediated production of commodity chemicals from carbon dioxide and renewable electricity. *BIORESOURTE TECHNOLOGY*. 228, 201 - 209. IF 2017 : 5.807;
- Matassa S, Verstraete W, Pikaar I, Boon N. 2016. Autotrophic nitrogen assimilation and carbon capture for microbial protein production by a novel enrichment of hydrogen-oxidizing bacteria. *Water Research* 101:137-146.(Impact factor: 5,528; Quantile: Q1)
- Matassa S, Boon N, Verstraete W. 2015. Resource recovery from used water: The manufacturing abilities of hydrogen-oxidizing bacteria. *Water Research* 68:467-478.(Impact factor: 5,323; Quantile: Q1)
- Hosseinkhani B, Hennebel T, Van Nevel S, Verschuere S, Yakimov MM, Cappello S, Blaghen M, Boon N. 2014. Biogenic Nanopalladium Based Remediation of Chlorinated Hydrocarbons in Marine Environments. *Environmental Science & Technology* 48:550-557.(Impact factor: 5,481; Quantile: Q1)

### Contact persons:

Louis Sileghem ([Louis.Sileghem@UGent.be](mailto:Louis.Sileghem@UGent.be))

Hydrogen Platform Manager UGent

T +32 496 63 16 01

Prof. Nico Boon ([Nico.Boon@UGent.be](mailto:Nico.Boon@UGent.be))

Prof. Ramon Ganigué ([Ramon.Ganigue@UGent.be](mailto:Ramon.Ganigue@UGent.be))

[www.cmet.ugent.be](http://www.cmet.ugent.be)

CMET (Building A, room A0.092)

Coupure Links 653

9000 Ghent

## *UGent: Ghent Institute for International Studies / Centre for Sustainable Development*

### Ghent University, Faculty of Political & Social Sciences

#### General expertise of the research group:

GIIS is conducting research into six distinctive research areas in two overarching domains: security & foreign policy, and the development of the multilateral system.

At CDO, scientific researchers from different disciplines (political scientists, economists, educational scientists, (bio)engineers, sociologists, environmentalists, physicists, urban planners, etc.) work together to conduct research on sustainable development. Taking sustainable development in its multiple dimensions (economic, social, physical-ecological, institutional and ethical) as a guiding – though not determining – perspective, interdisciplinarity and transdisciplinarity are key aspects of research conducted at CDO.

#### Specific hydrogen- related expertise & research topics:

- Geopolitics and international governance of H<sub>2</sub>
- political analysis, socio-technical system innovation, governance of transitions such as the transition of the energy-intensive industry

#### Available equipment/tools:

#### Participating in FL/B/EU funded projects with H<sub>2</sub> related research:

- See website: [research.ugent.be](https://research.ugent.be)

#### International collaborations:

International Renewable Energy Agency (IRENA) – geopolitics of the hydrogen economy



### The politics of the circular economy



### Sustainable Cities



### Science, Technology and Politics



### Indicators, Assessments and Monitoring



### Sustainability Education



### Transitions and Future Studies



#### Main relevant publications:

- See website: [biblio.ugent.be](http://biblio.ugent.be)
- Van de Graaf, T., Overland, I., Scholten, D., & Westphal, K. (2020). The new oil? The geopolitics and international governance of hydrogen. *Energy Research & Social Science*, 70, 101667.
- Van de Graaf, T. (2021). The Next Prize: Geopolitical Stakes in the Clean Hydrogen Race. In *Oxford Energy Forum* (No. 126, pp. 30-34).

#### Contact persons:

Louis Sileghem ([Louis.Sileghem@UGent.be](mailto:Louis.Sileghem@UGent.be))  
Hydrogen Platform Manager UGent  
T +32 496 63 16 01

Prof. Thijs Van de Graaf ([Thijs.VandeGraaf@UGent.be](mailto:Thijs.VandeGraaf@UGent.be))  
Ghent Institute for International Studies  
Universiteitstraat 8  
9000 Ghent  
Prof. Erik Paredis ([Erik.Paredis@UGent.be](mailto:Erik.Paredis@UGent.be))  
Centre for Sustainable Development  
Poel 16  
9000 Ghent

## UGent: Centre of environmental & energy law

### Ghent University, Faculty of Law Criminology

#### General expertise of the research group:

Energy Law is the part of the law that regulates the human acting dealing with production/exploitation, transports an use of energy. The contemporary Energy Law is very recent. Especially the European liberalisation and Climate change have led to a juridification of the traditional technical approach of “the energy business” and to an appearance of Energy law.

Energy Law is extremely technical and complex, fast evolving Law Branch.

The Centre for Environmental and Energy Law has built a specific expert’s centre regarding Energy Law. This unit works within Ghent University together to bound research, valorization and cooperation with other research groups of Energy Law.

#### Specific hydrogen- related expertise & research topics:

- The division of competence in the field of hydrogen and green molecules;
- Certification of hydrogen en green molecules

#### Participating in FL/B/EU funded projects with H<sub>2</sub> related research:

- See website: [research.ugent.be](http://research.ugent.be)

#### International collaborations:

#### Main relevant publications:

- See website: [biblio.ugent.be](http://biblio.ugent.be)
- Vandendriessche F, Claeys P. “Target setting” in het Europese energie- en klimaatbeleid : het “Clean Energy Package.” TIJDSCHRIFT VOOR MILIEURECHT. 2019;(3):262–83.
- Maes T, Van Eetvelde G, De Ras E, Block C, Pisman A, Verhofstede B, et al. Energy management on industrial parks in Flanders. RENEWABLE & SUSTAINABLE ENERGY REVIEWS. 2011;15(4):1988–2005.

#### Contact persons:

Louis Sileghem ([Louis.Sileghem@UGent.be](mailto:Louis.Sileghem@UGent.be))

Hydrogen Platform Manager UGent

T +32 496 63 16 01

Prof. Dr. Frederik Vandendriessche ([Frederik.Vandendriessche@UGent.be](mailto:Frederik.Vandendriessche@UGent.be))

Ghent University

Campus Aula

Department of European, Public and International Law

Universiteitstraat 4

9000 Gent

Belgium



**WaterstofNet**

Open Manufacturing Campus  
Slachthuisstraat 112 bus 1  
2300 Turnhout  
Belgium

T +32 (0)14 40 12 19

Contact person: Isabel François

E-mail: [Isabel.Francois@waterstofnet.eu](mailto:Isabel.Francois@waterstofnet.eu)

*Office The Netherlands*

Automotive Campus  
Automotive Campus 30  
5708 JZ Helmond  
The Netherlands



WaterstofNet

[waterstofnet.eu](http://waterstofnet.eu)